

**Blue Brixx**

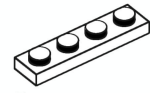

# 1



2x



1x

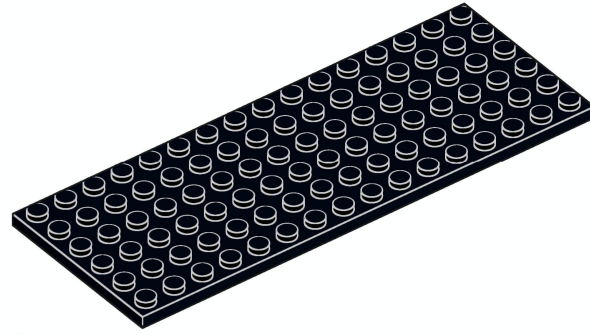

2x





# 2

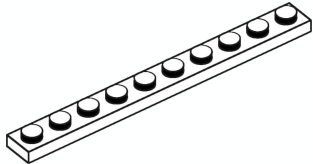

8x

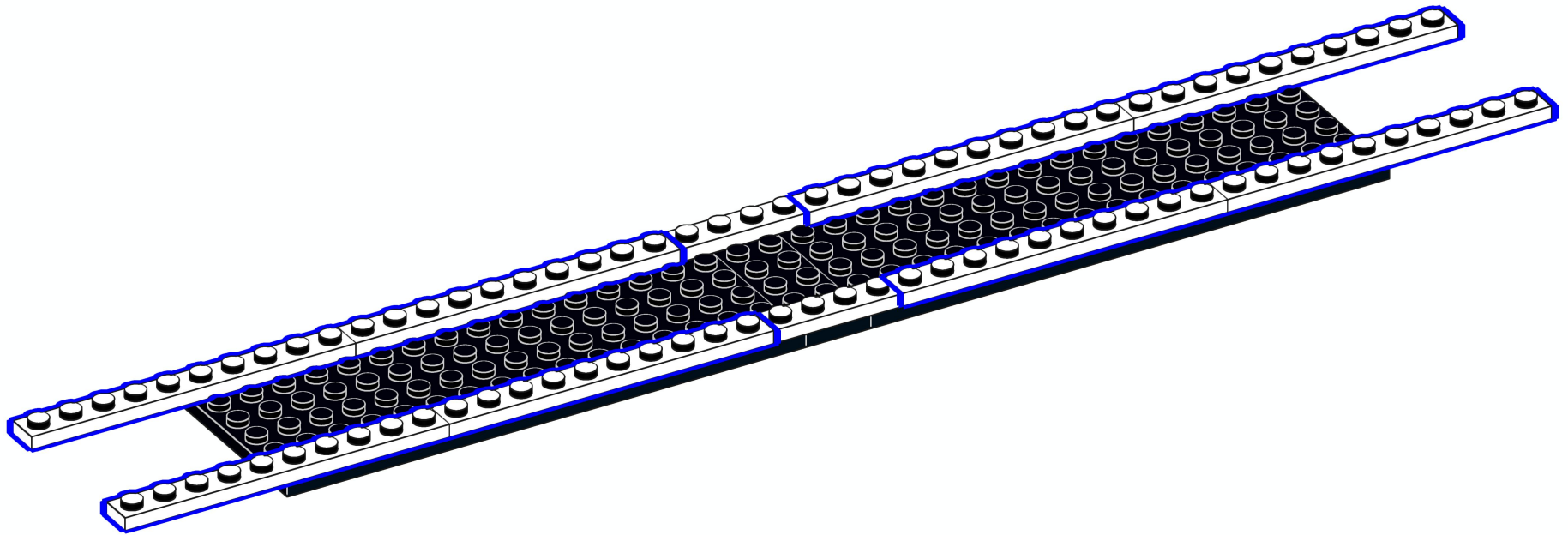

3

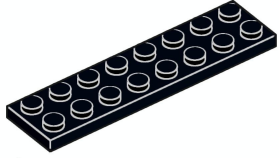

4x

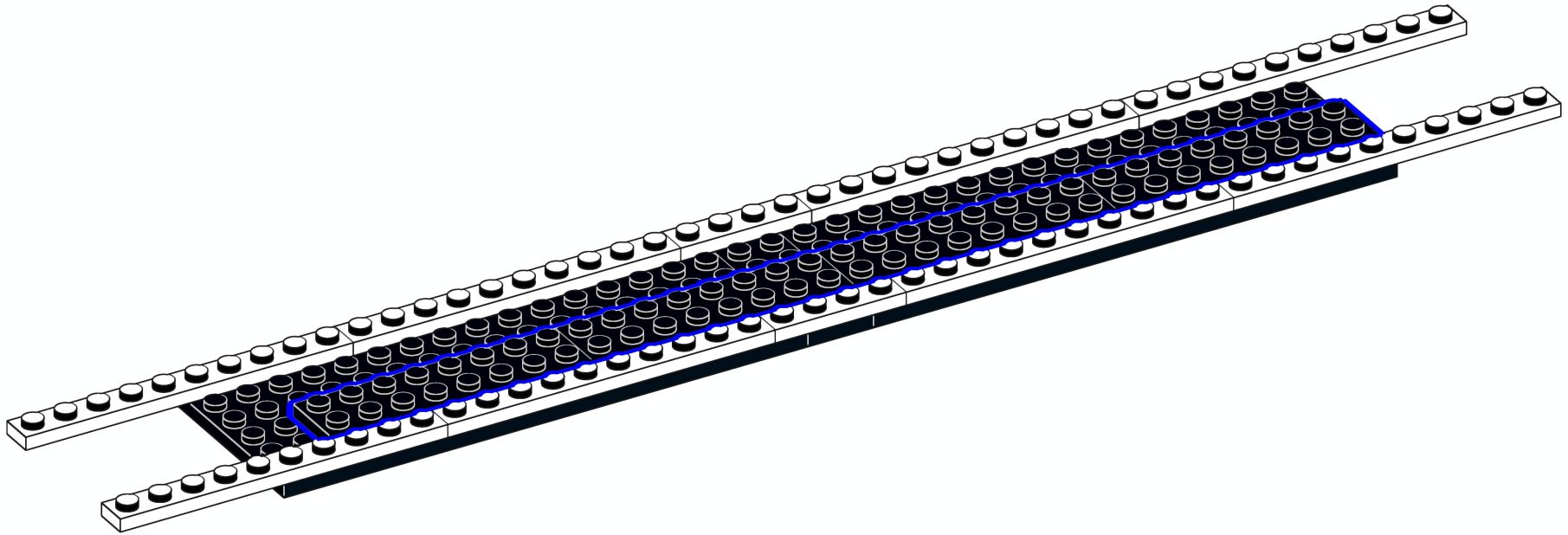

4

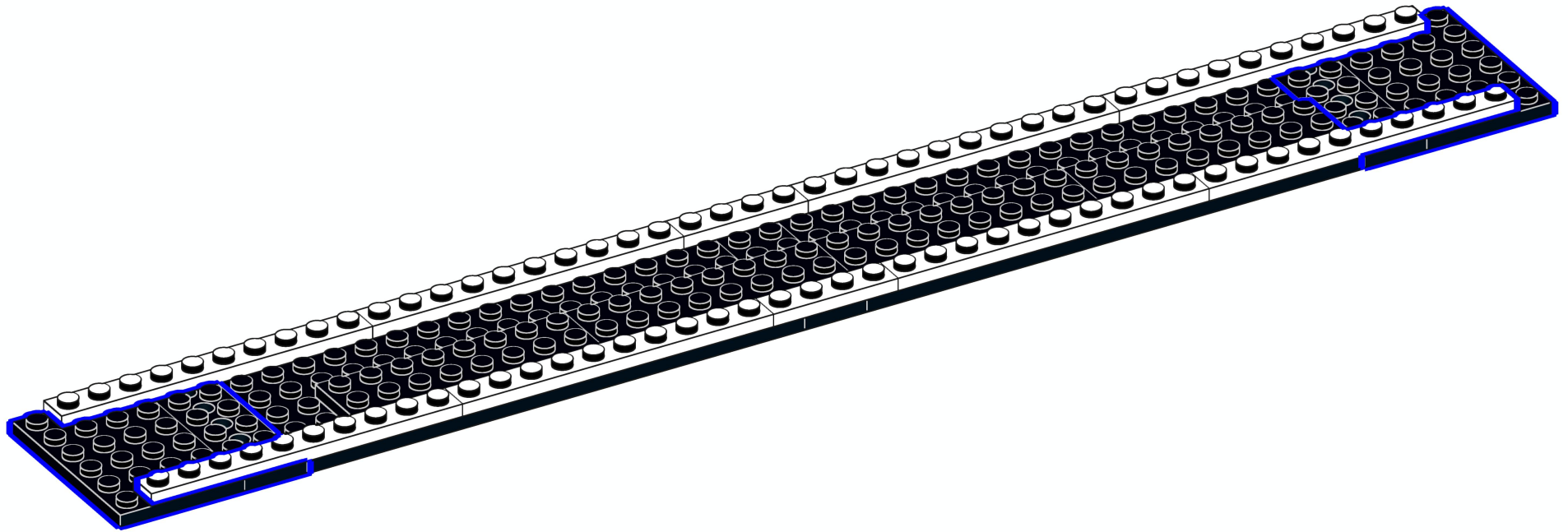
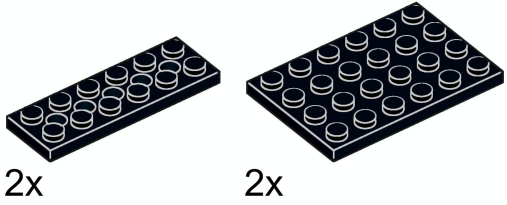

5

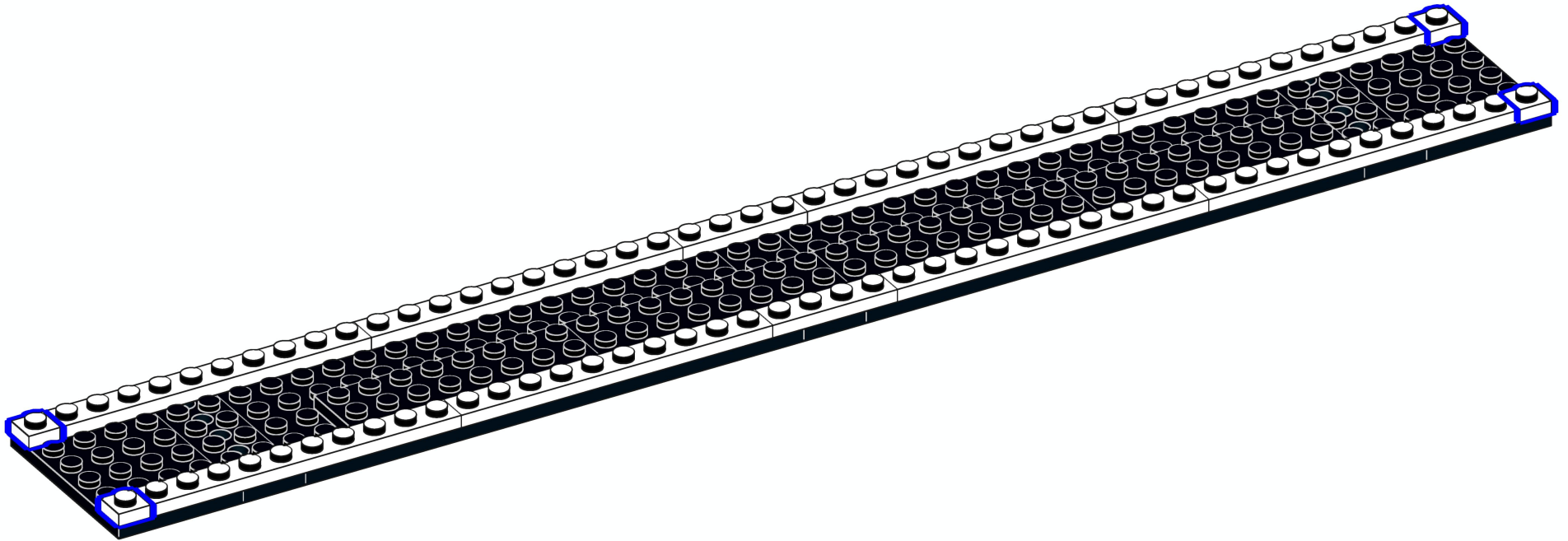

6

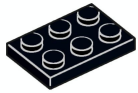

4x



2x

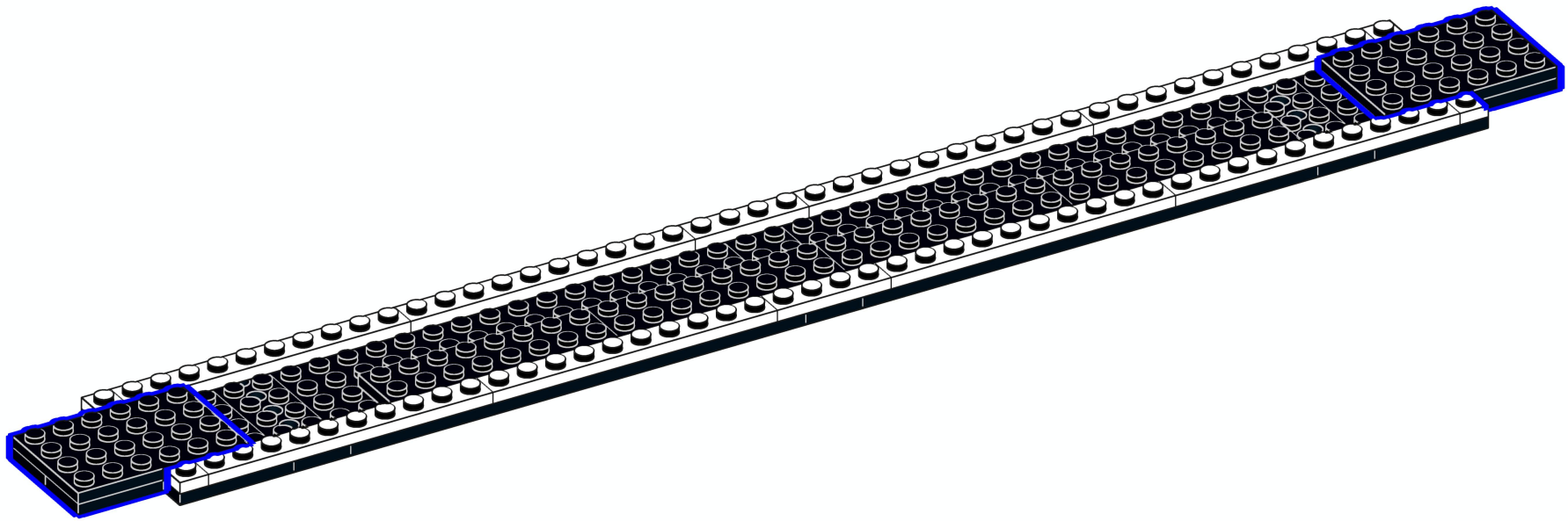

7

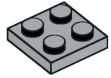

1x

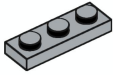

3x

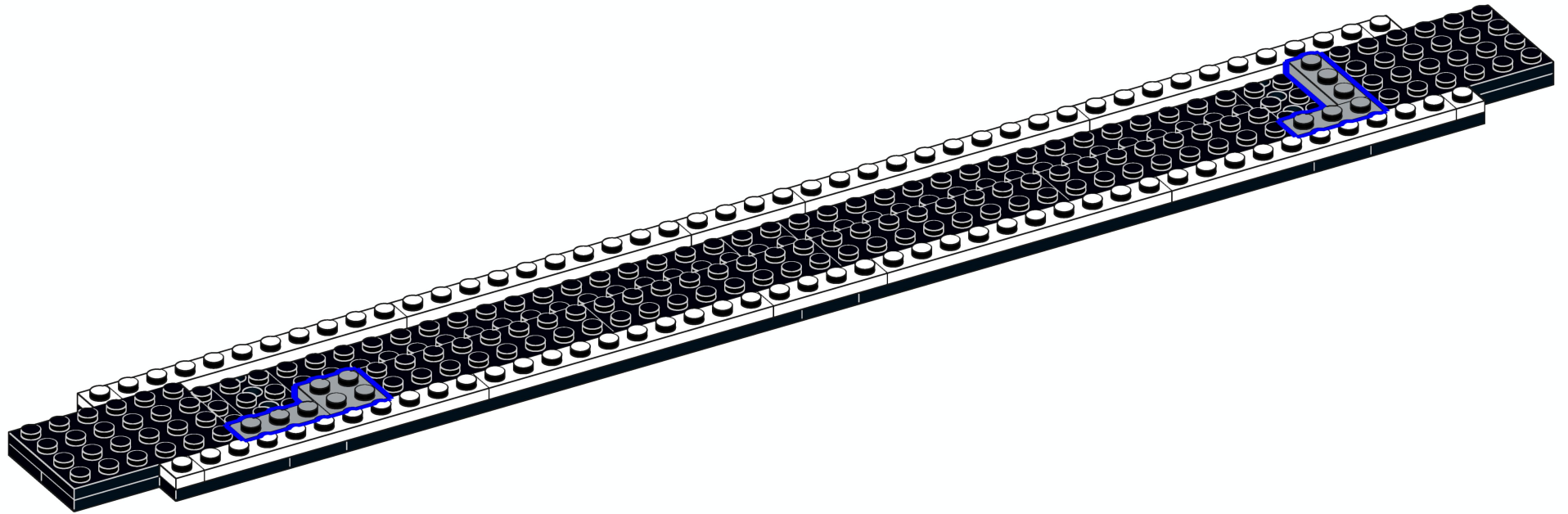



8

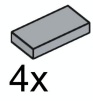

4x

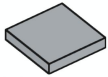

7x

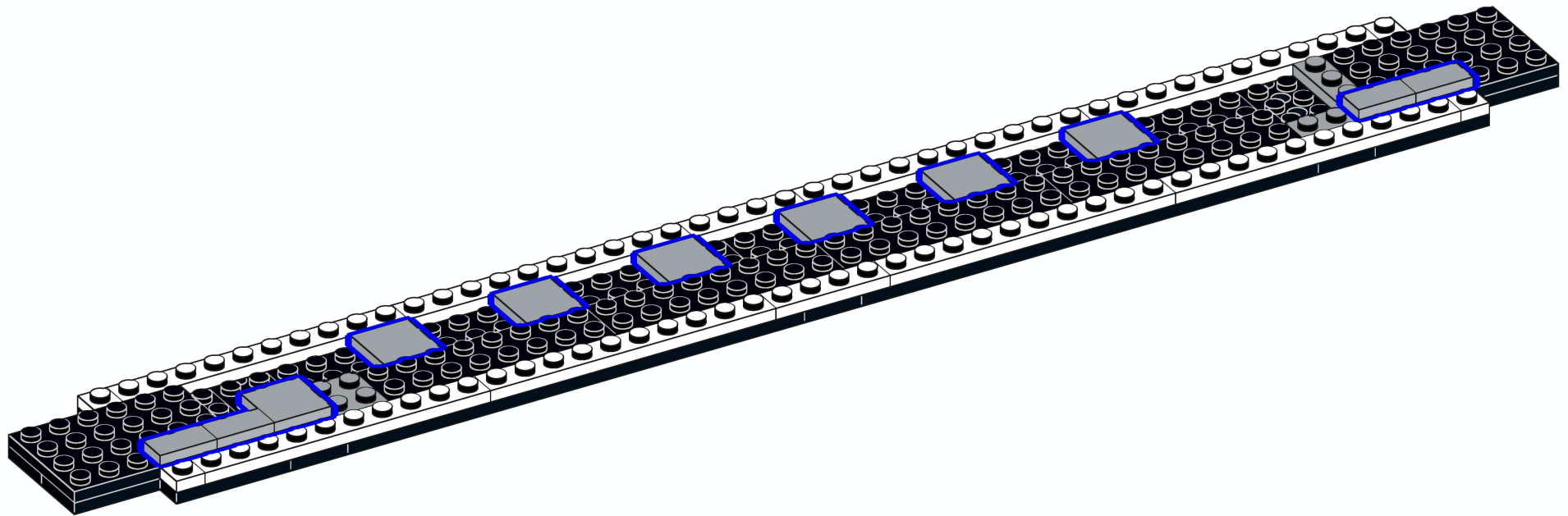

9

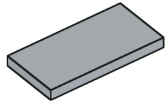

11x

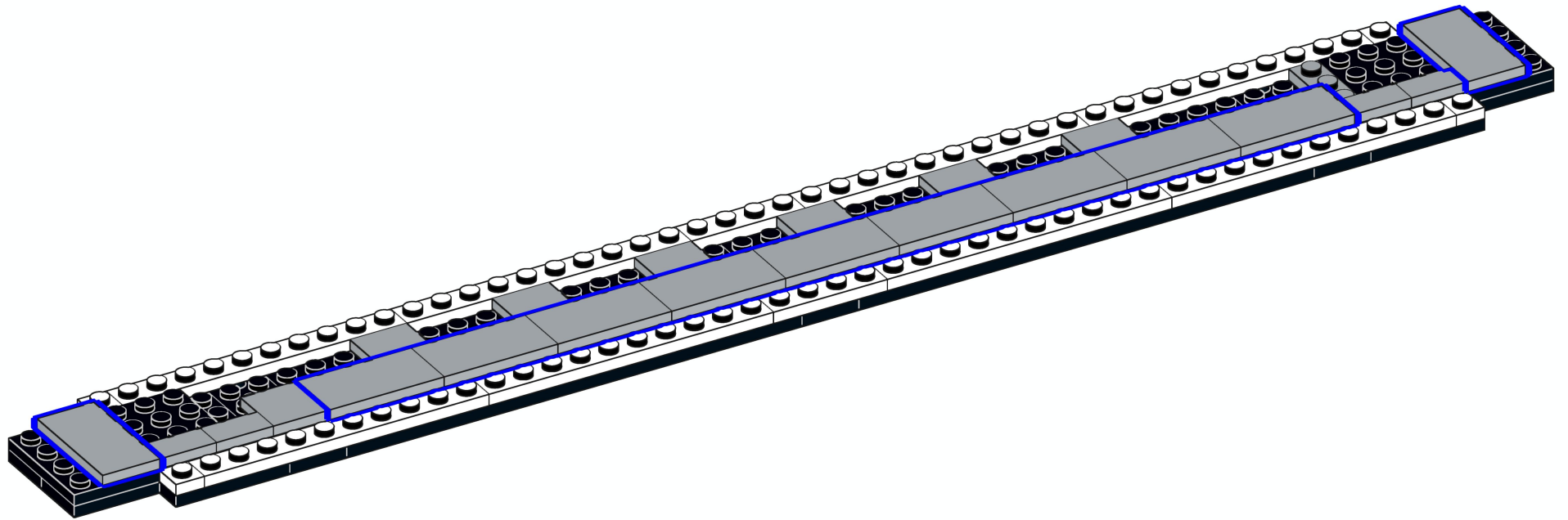

# 10

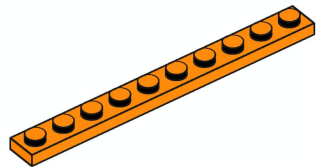

6x

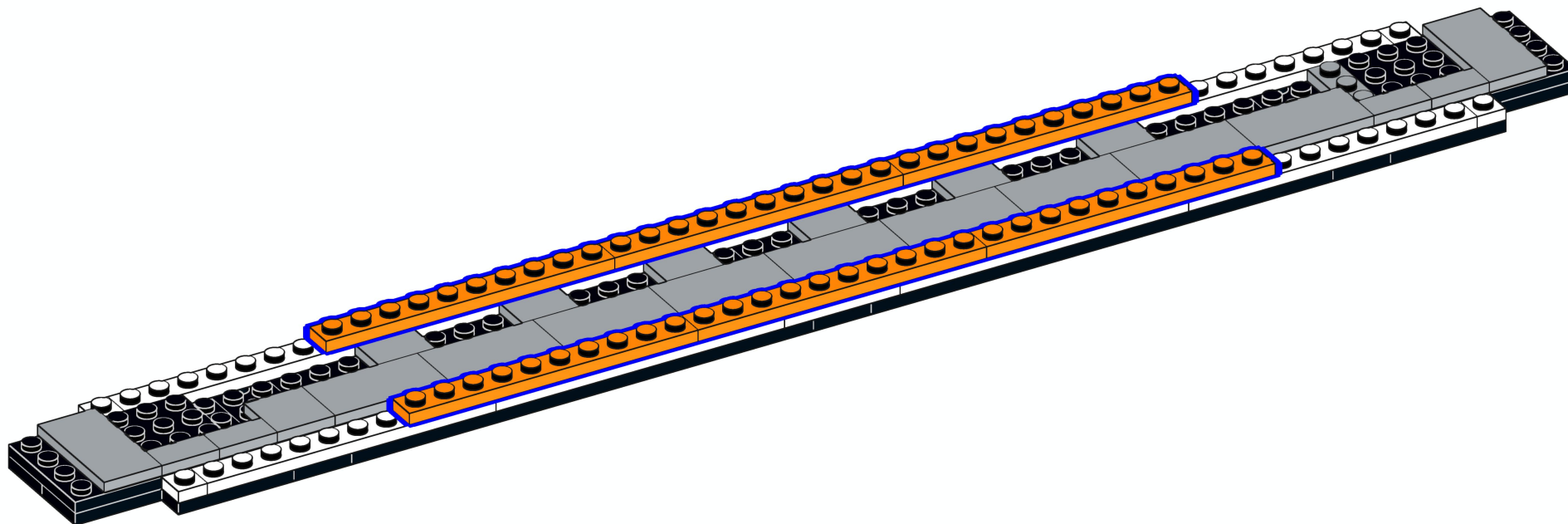

# 11

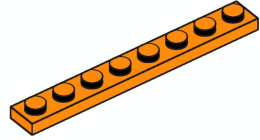

4x

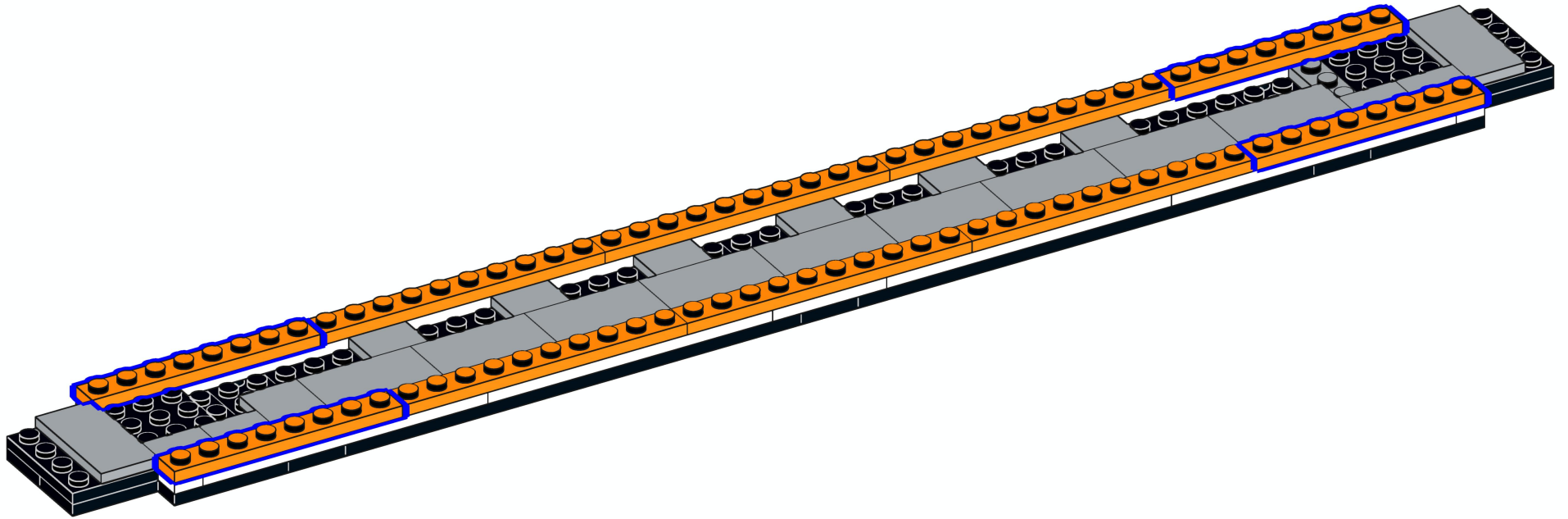

# 12

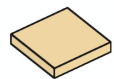

7x



14x



14x



7x

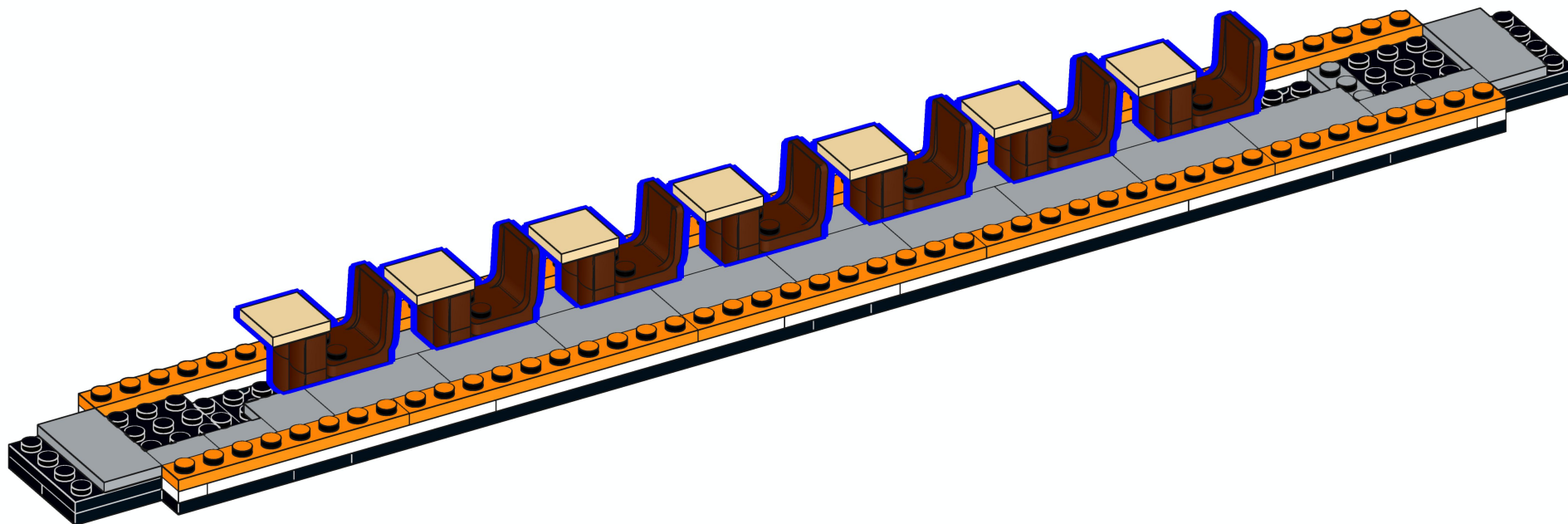

# 13

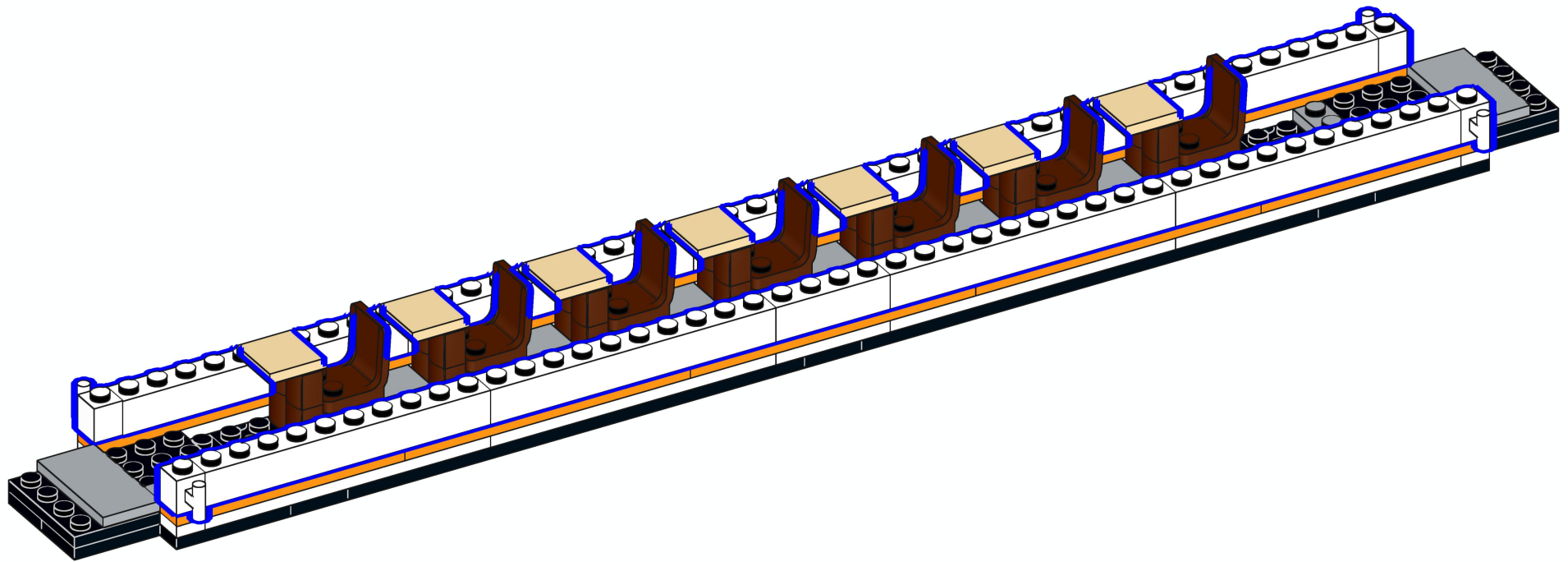
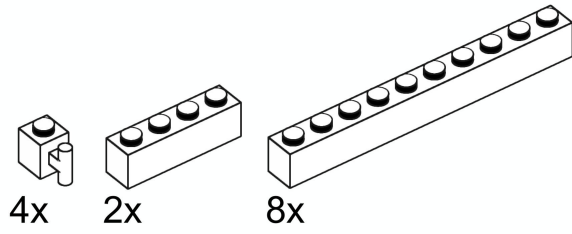



# 14

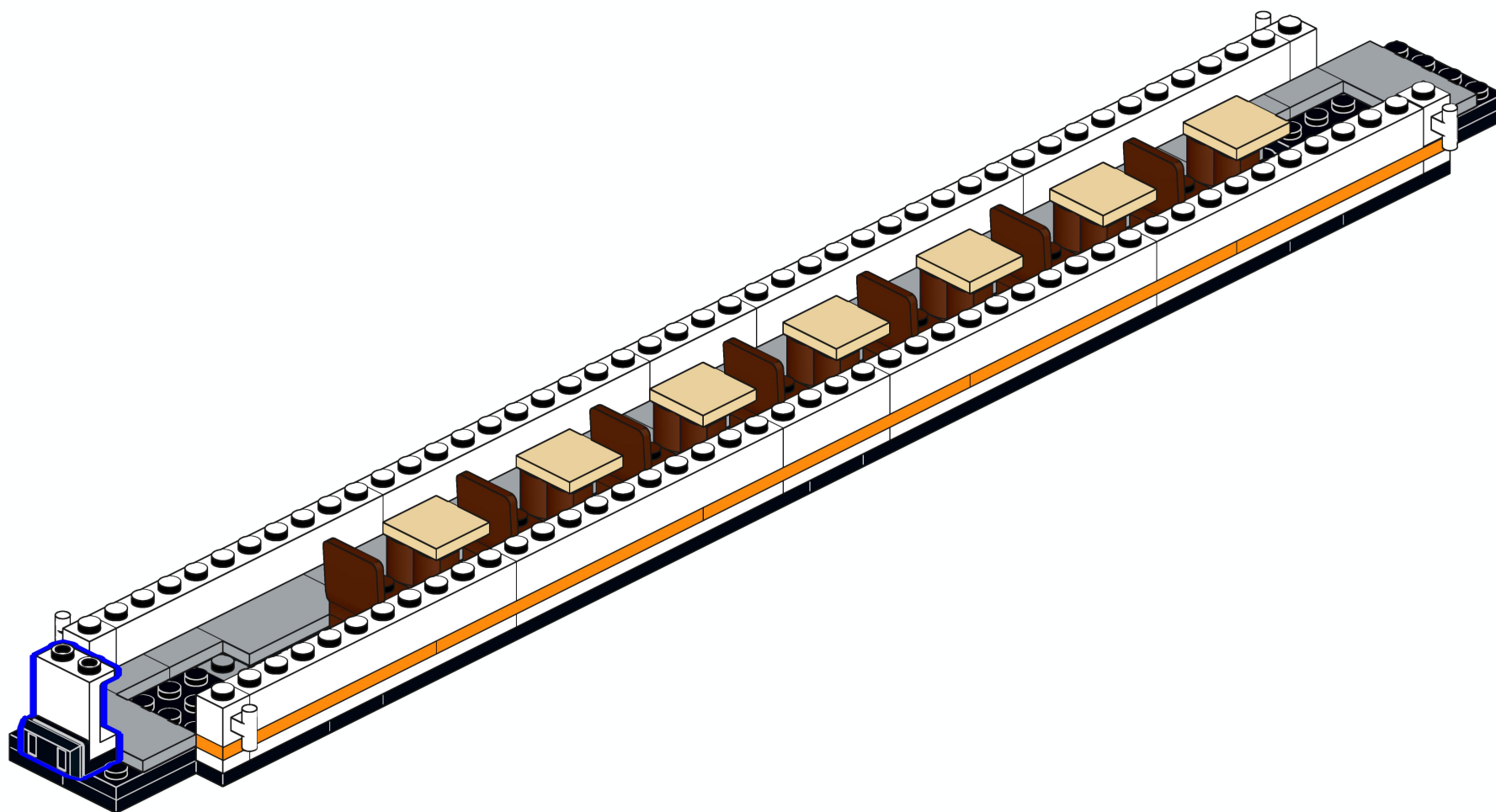
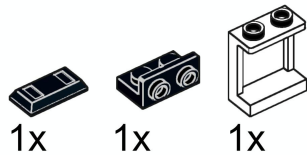

# 15

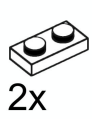





2x

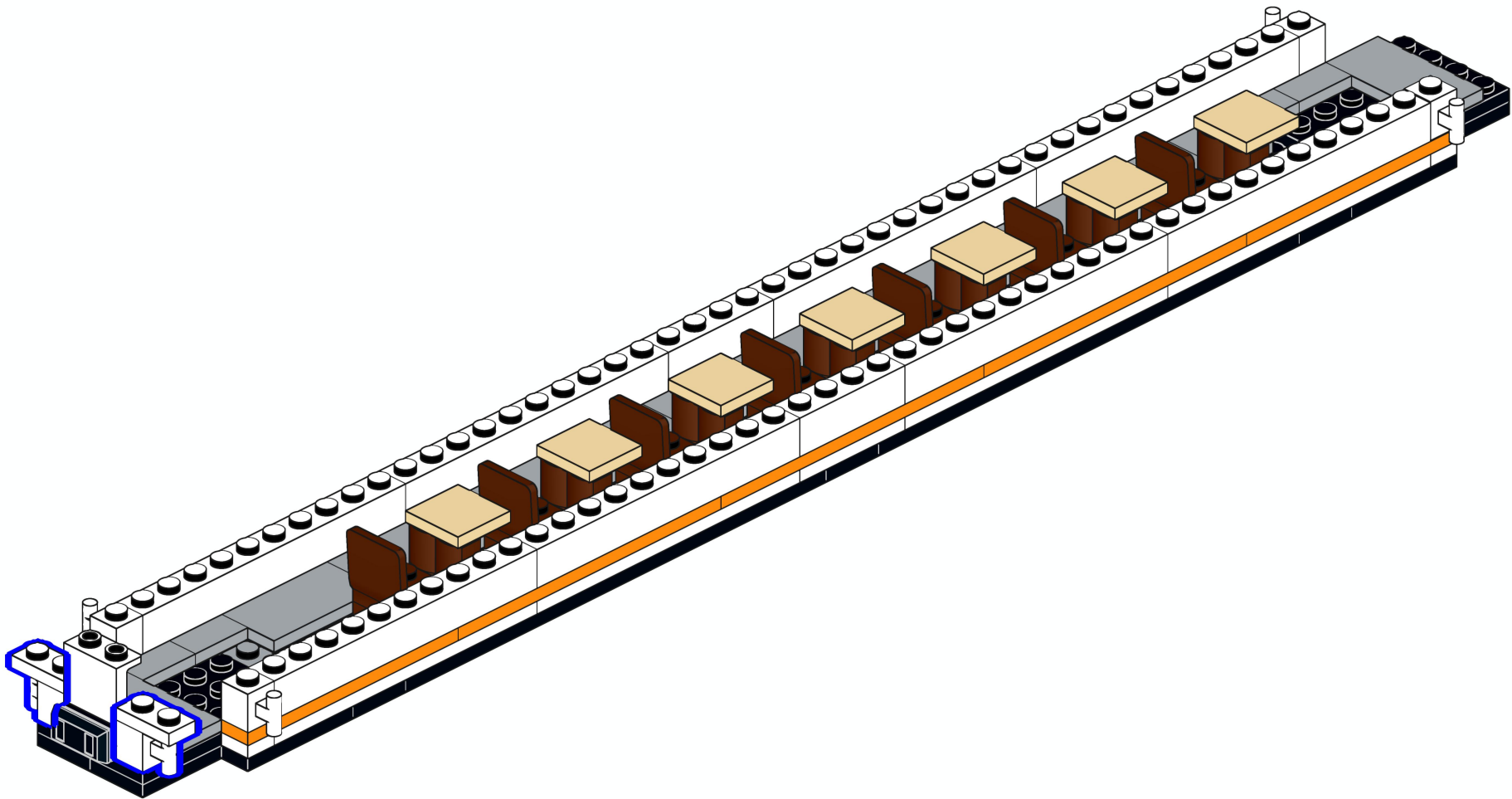

2x



# 16

- 2x 
- 2x 
- 2x 
- 2x 

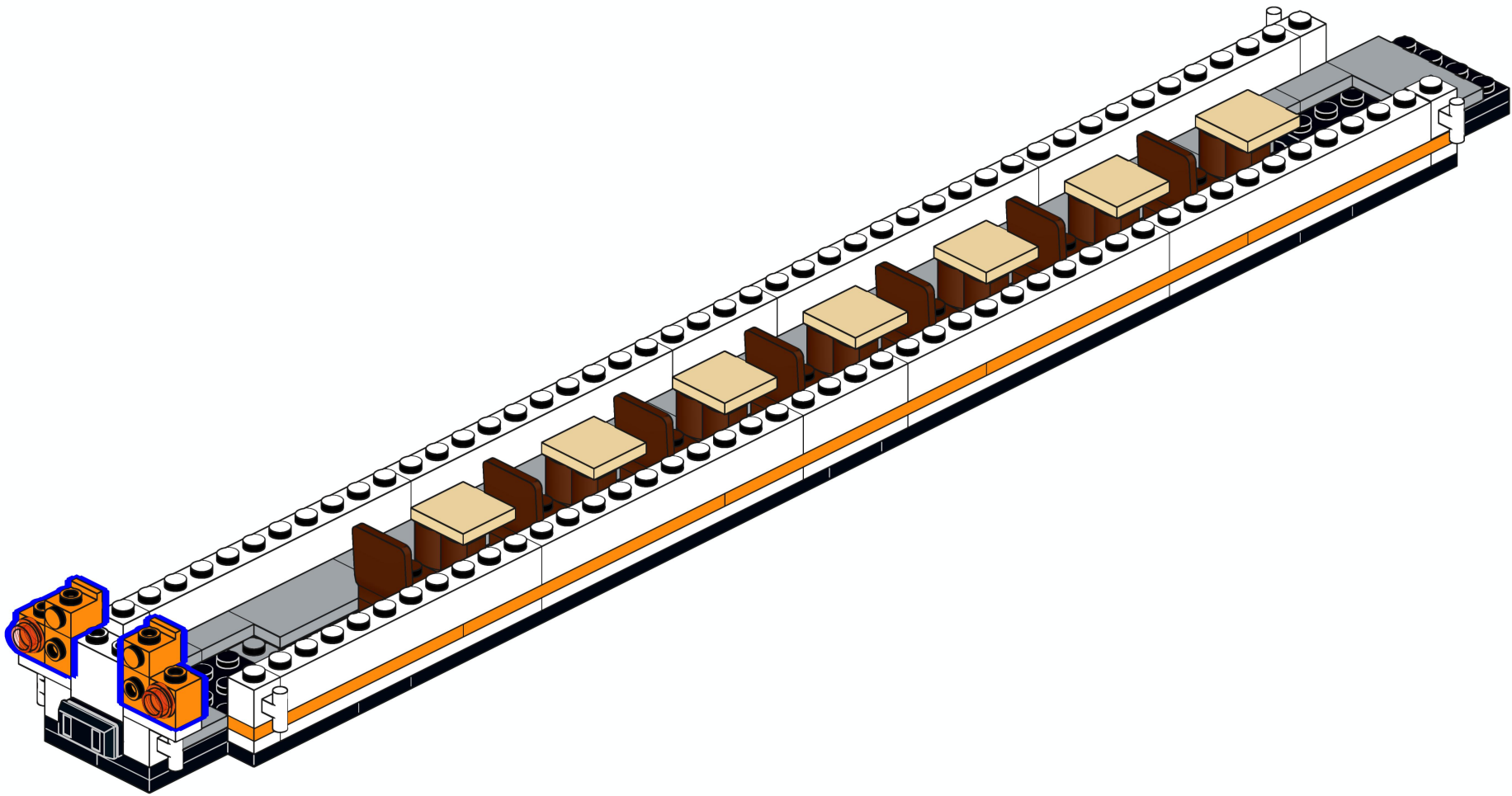

# 17



4x

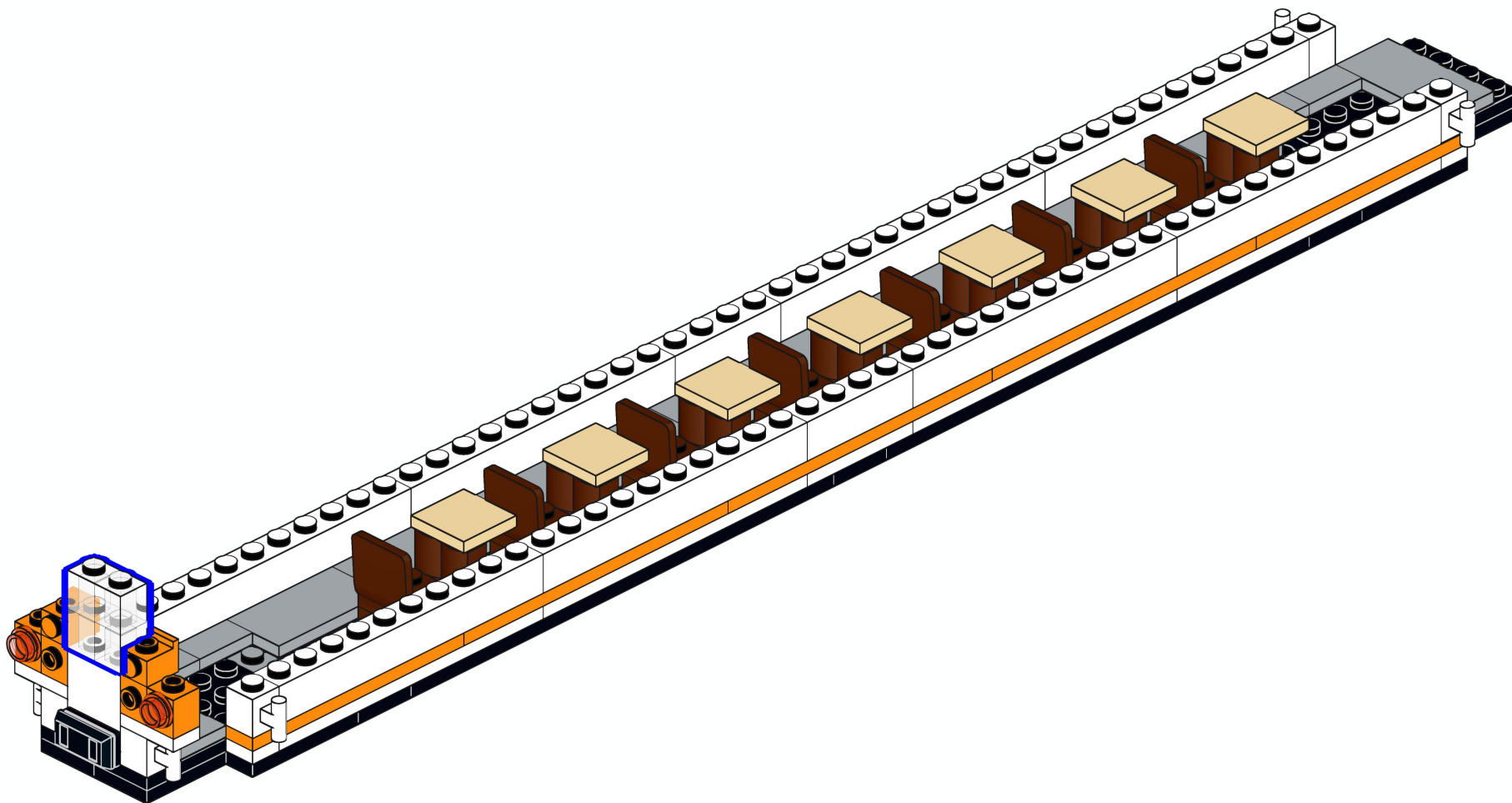

# 18



6x

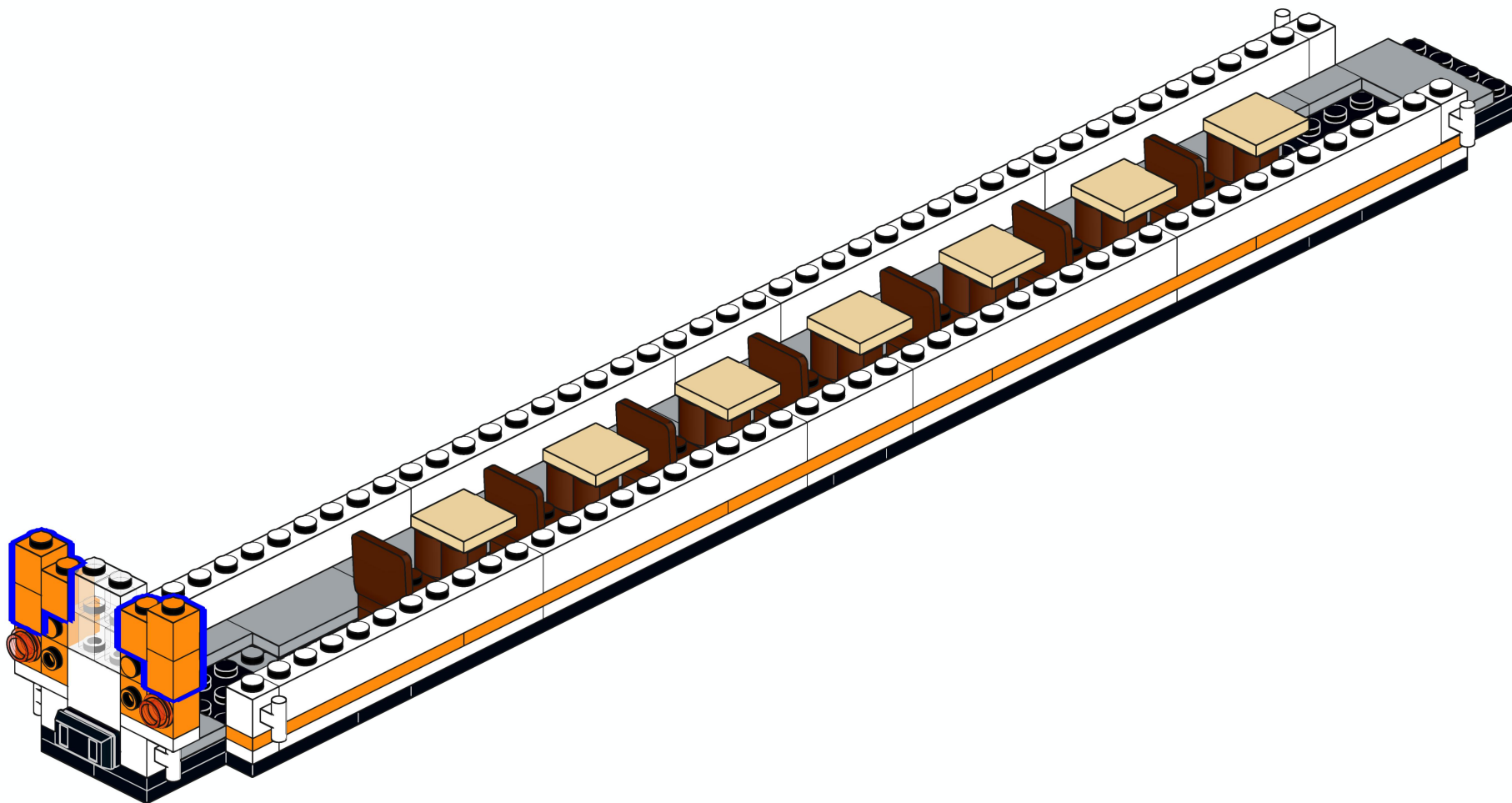

# 19

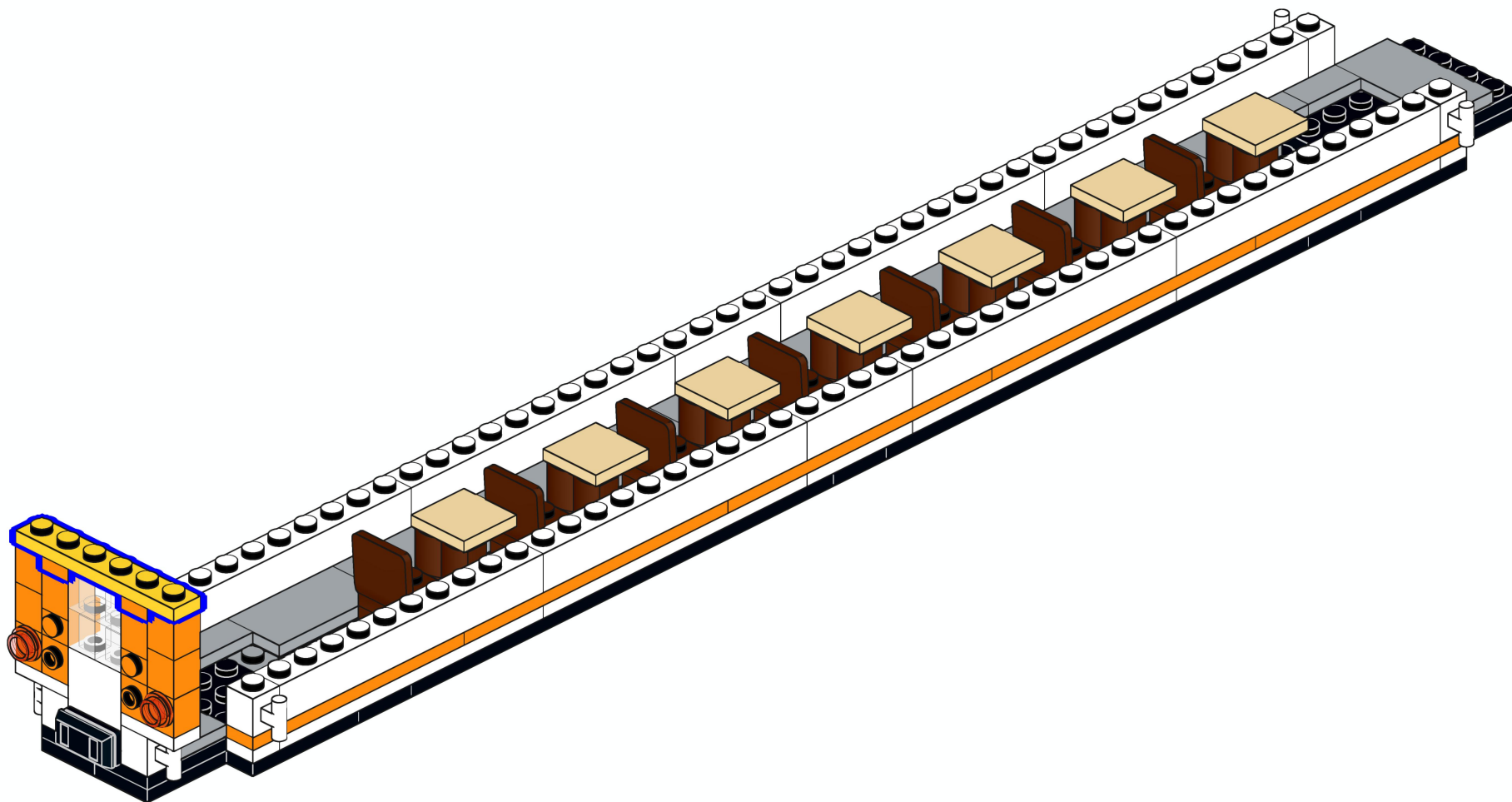
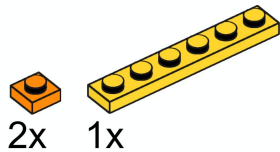



# 20

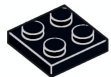

1x

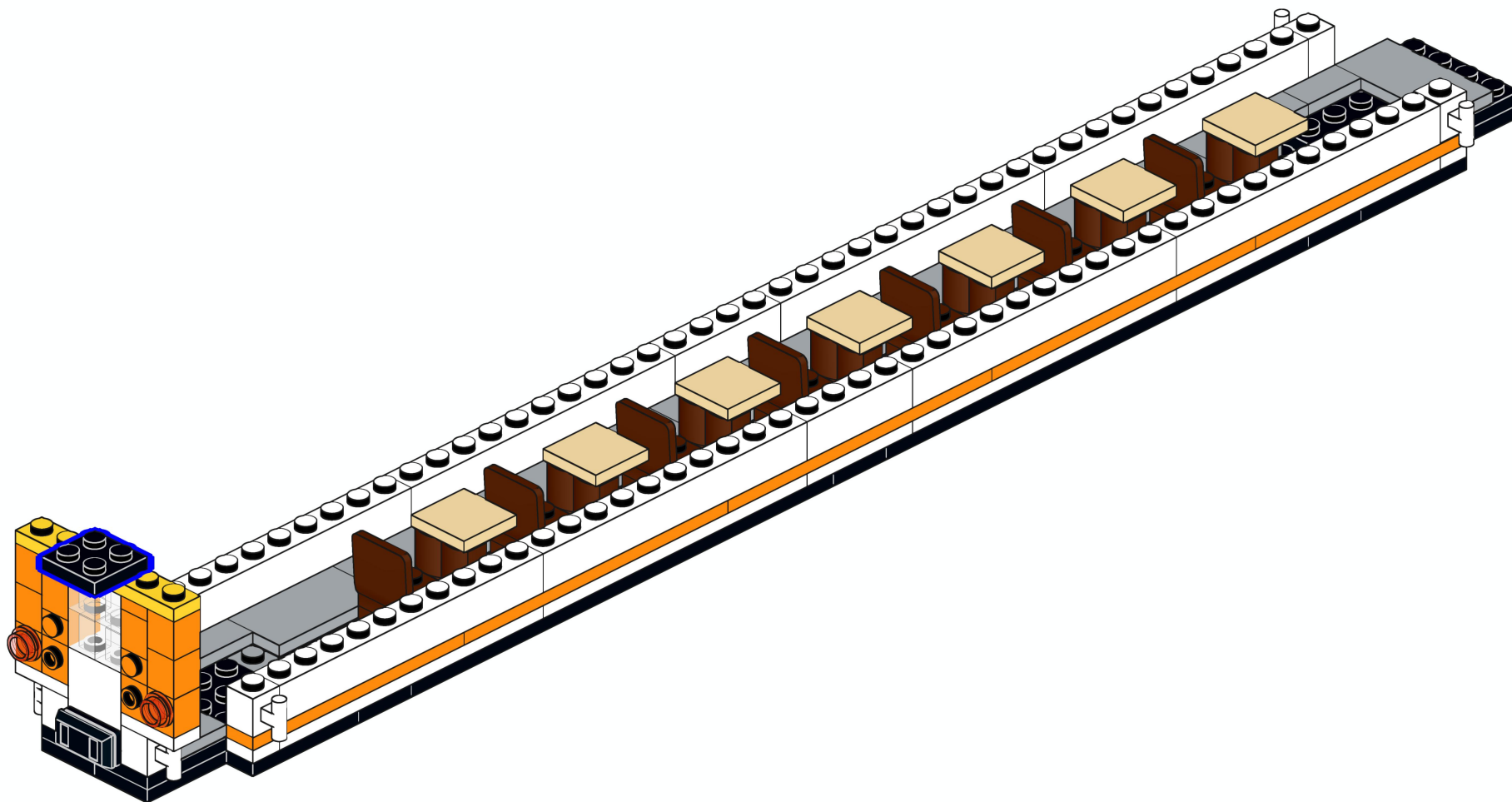

# 21

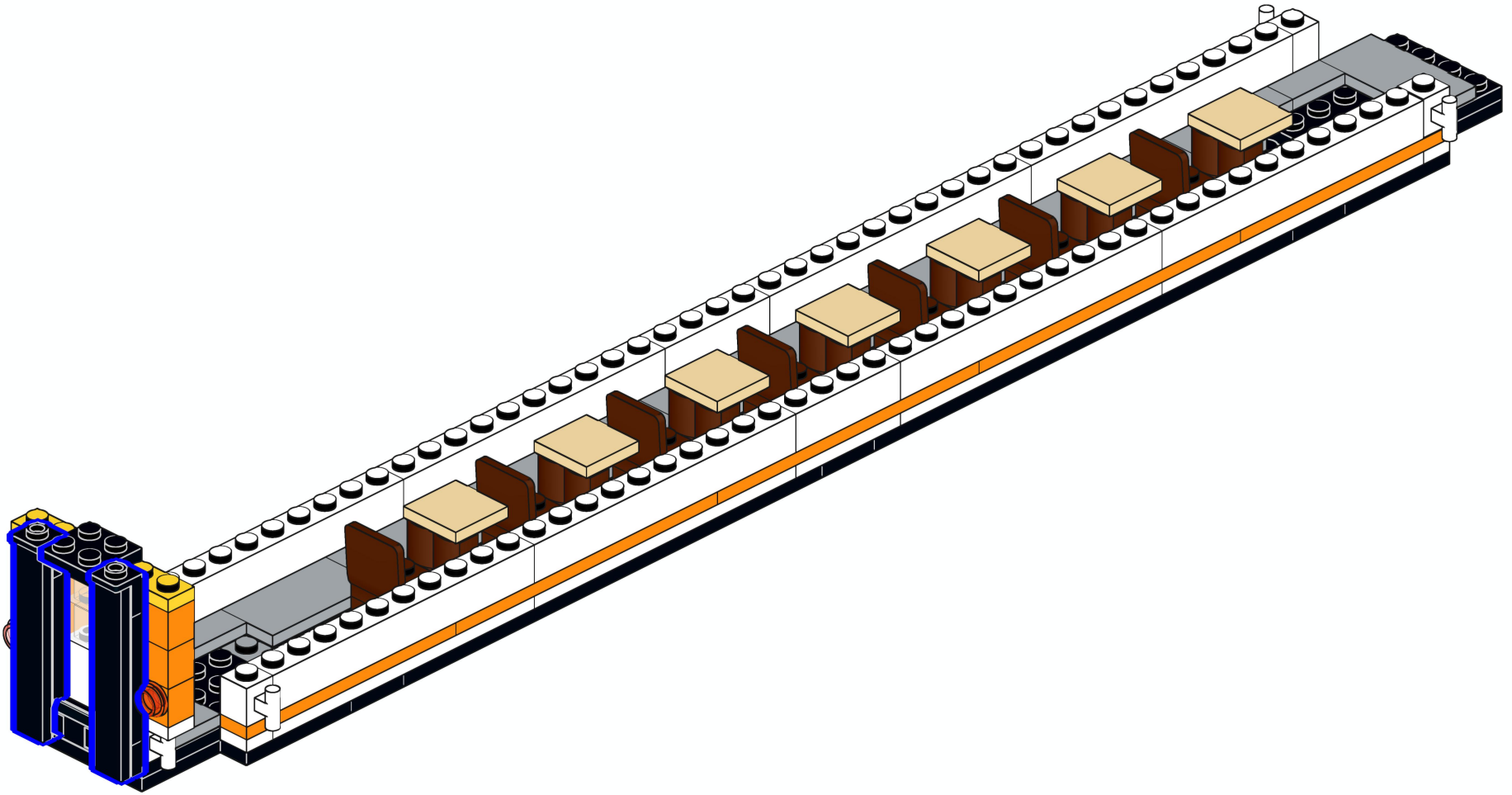
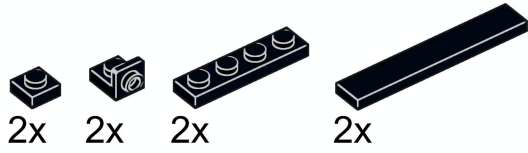

# 22



1x

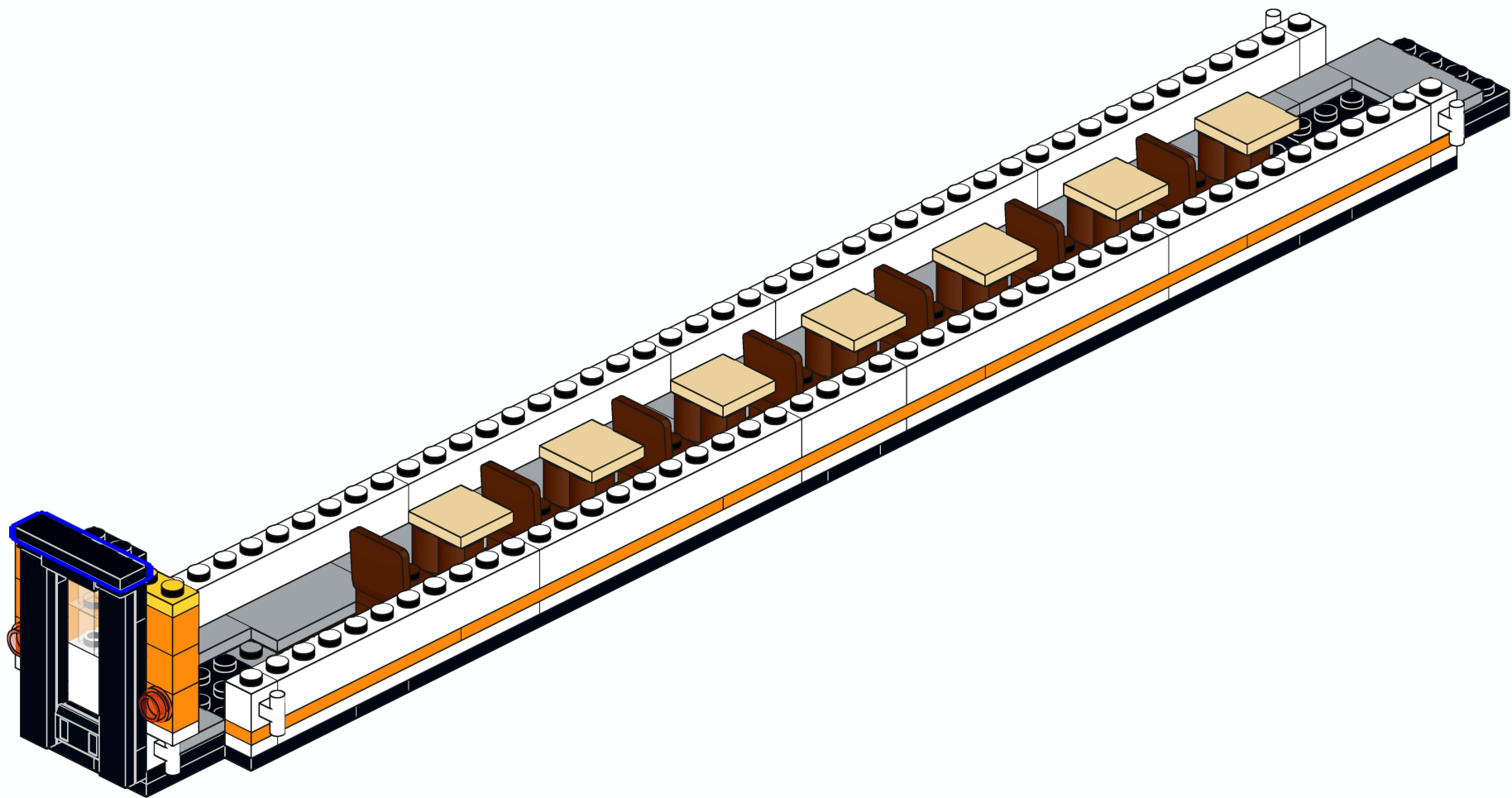

# 23



1x



1x

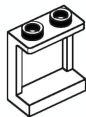



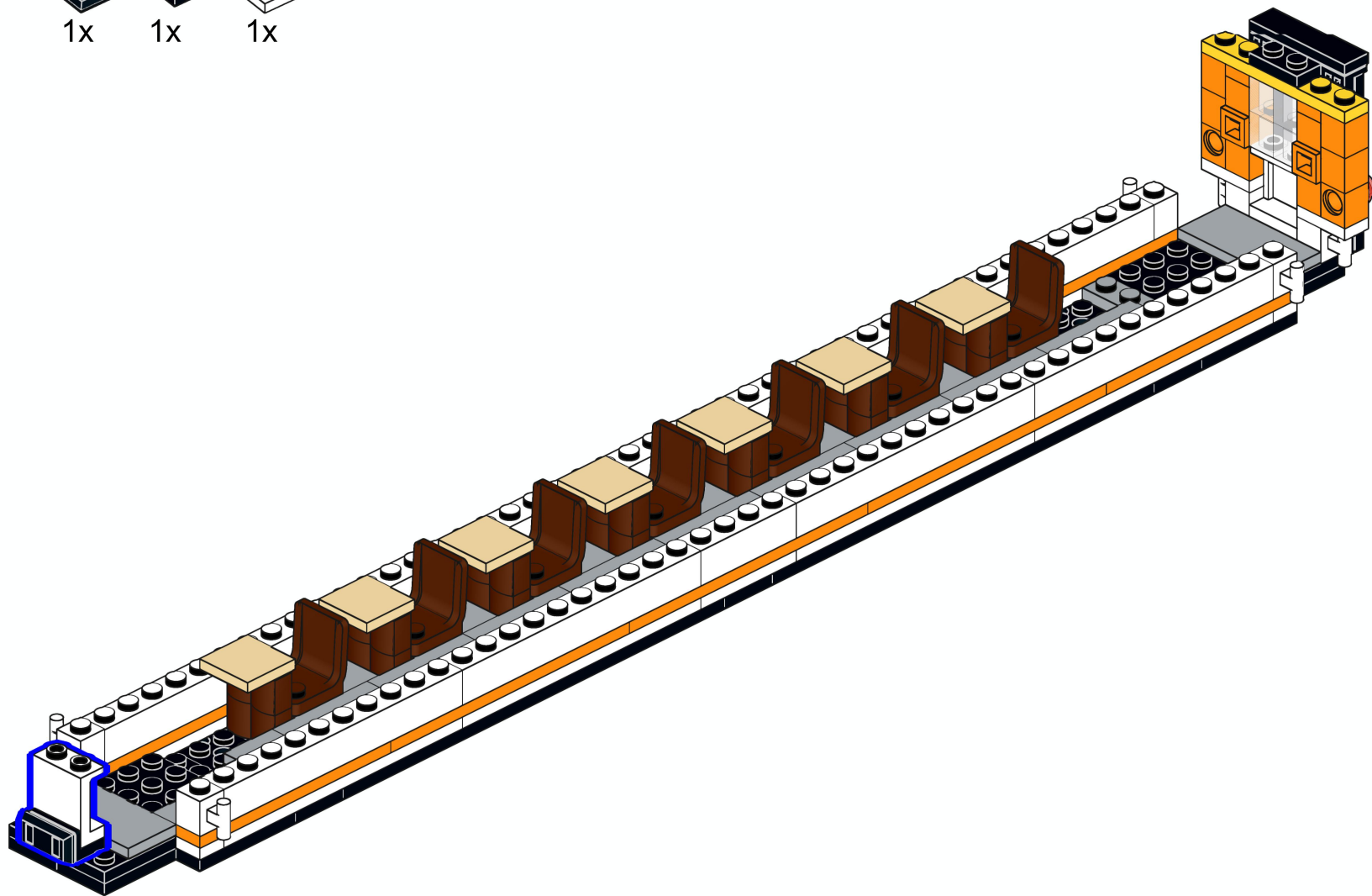

1x

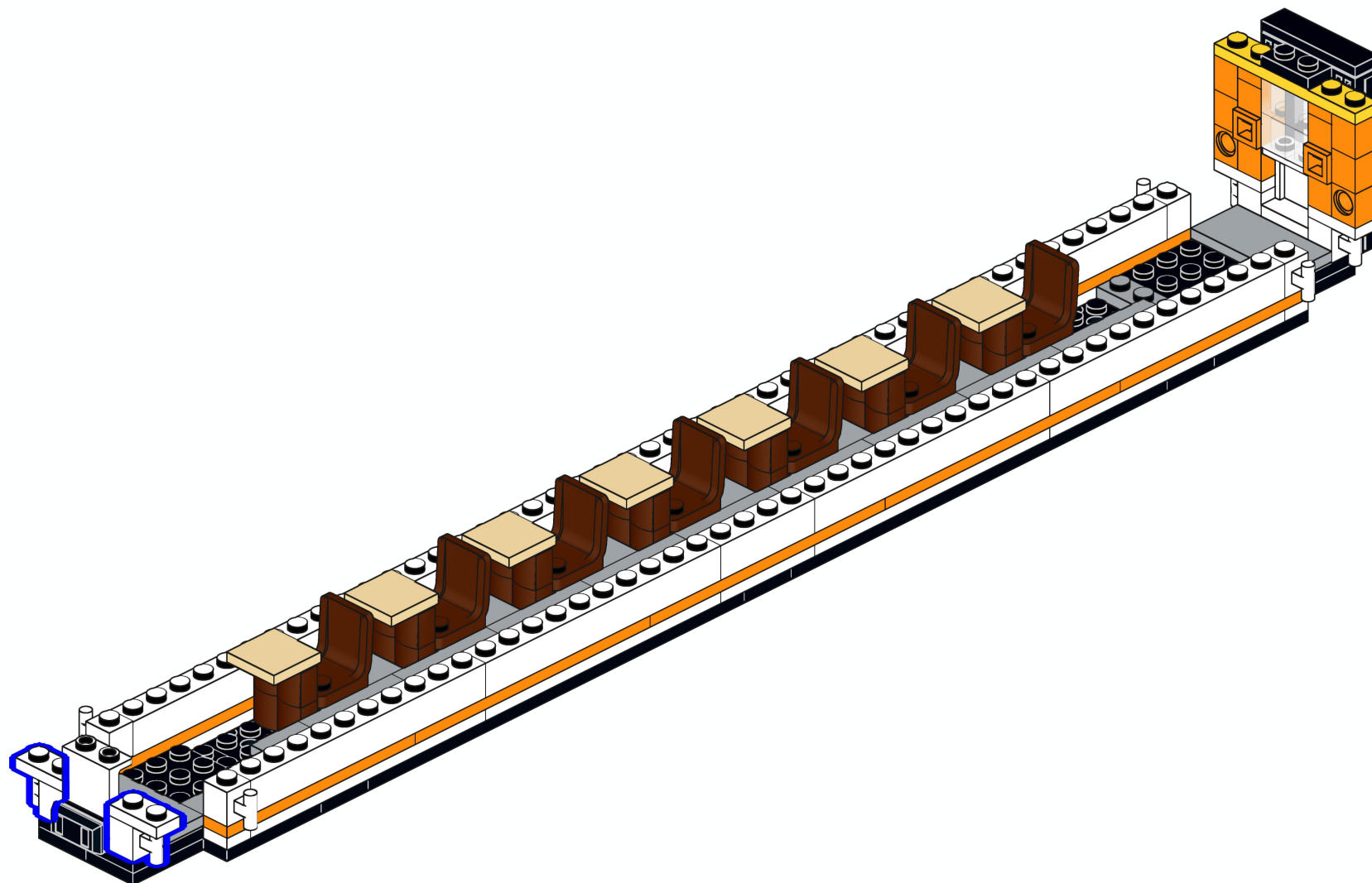
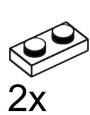

# 24



# 25

-  2x
-  2x
-  2x
-  2x

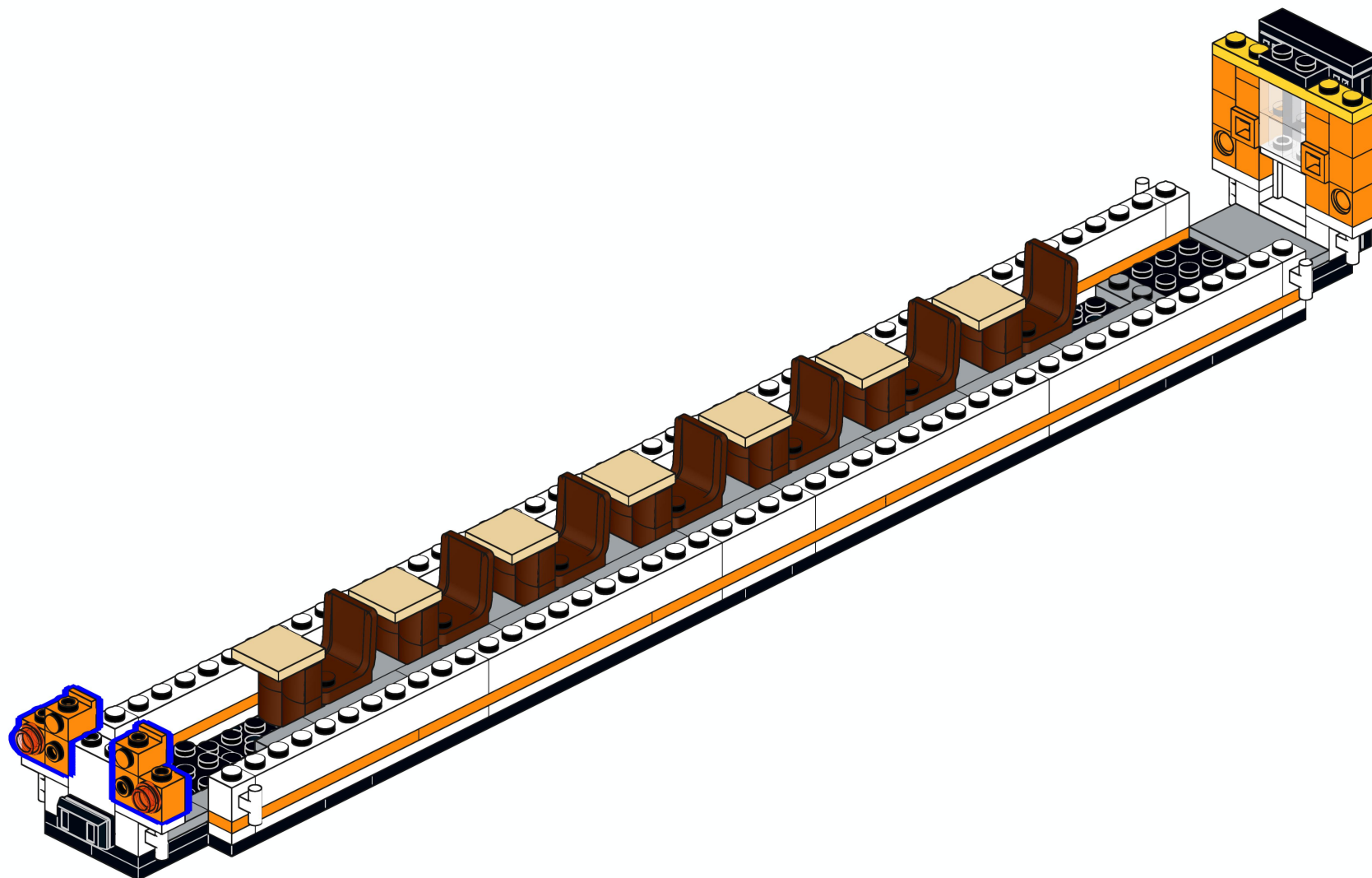



# 26



4x

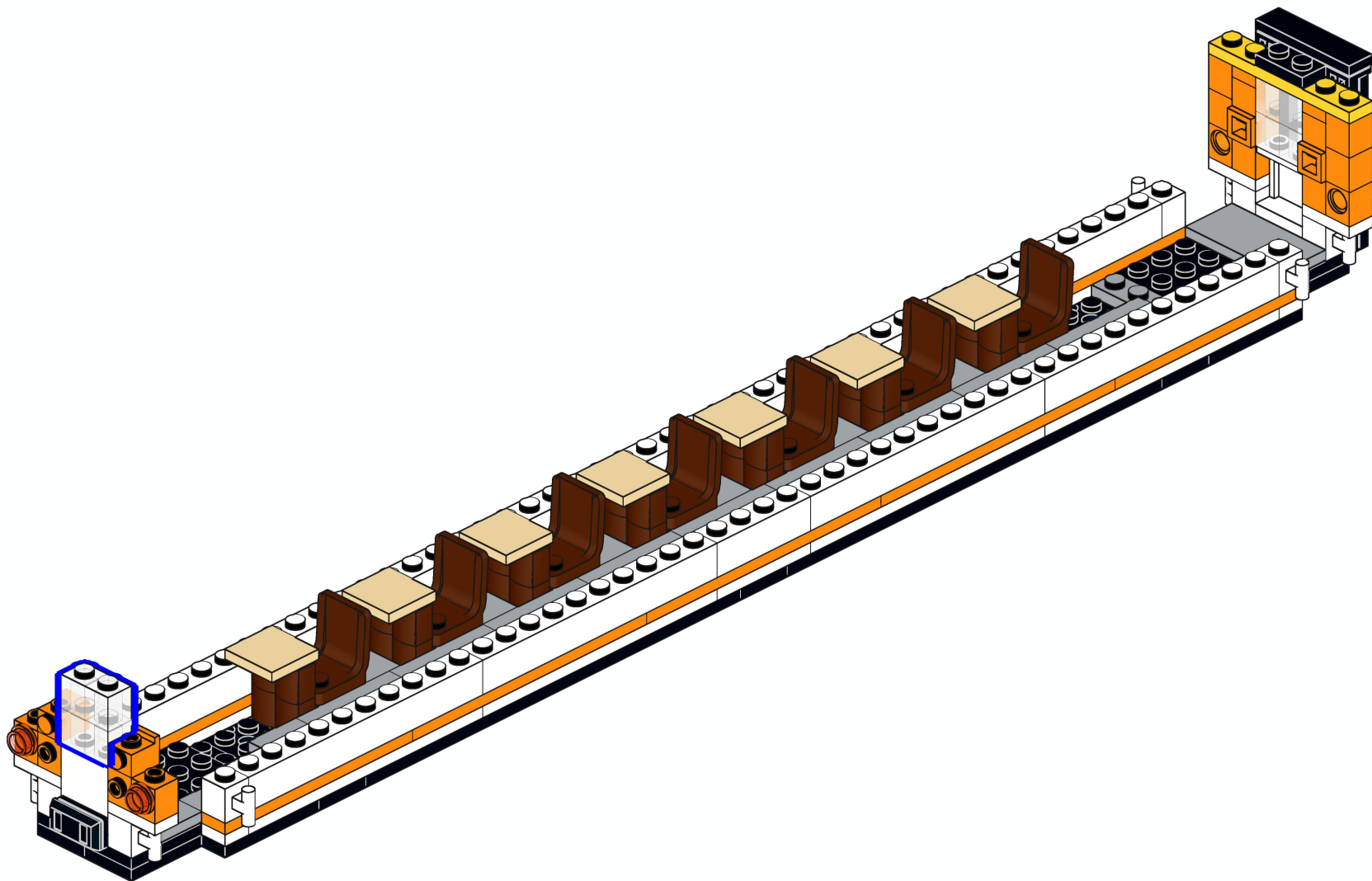

# 27



6x

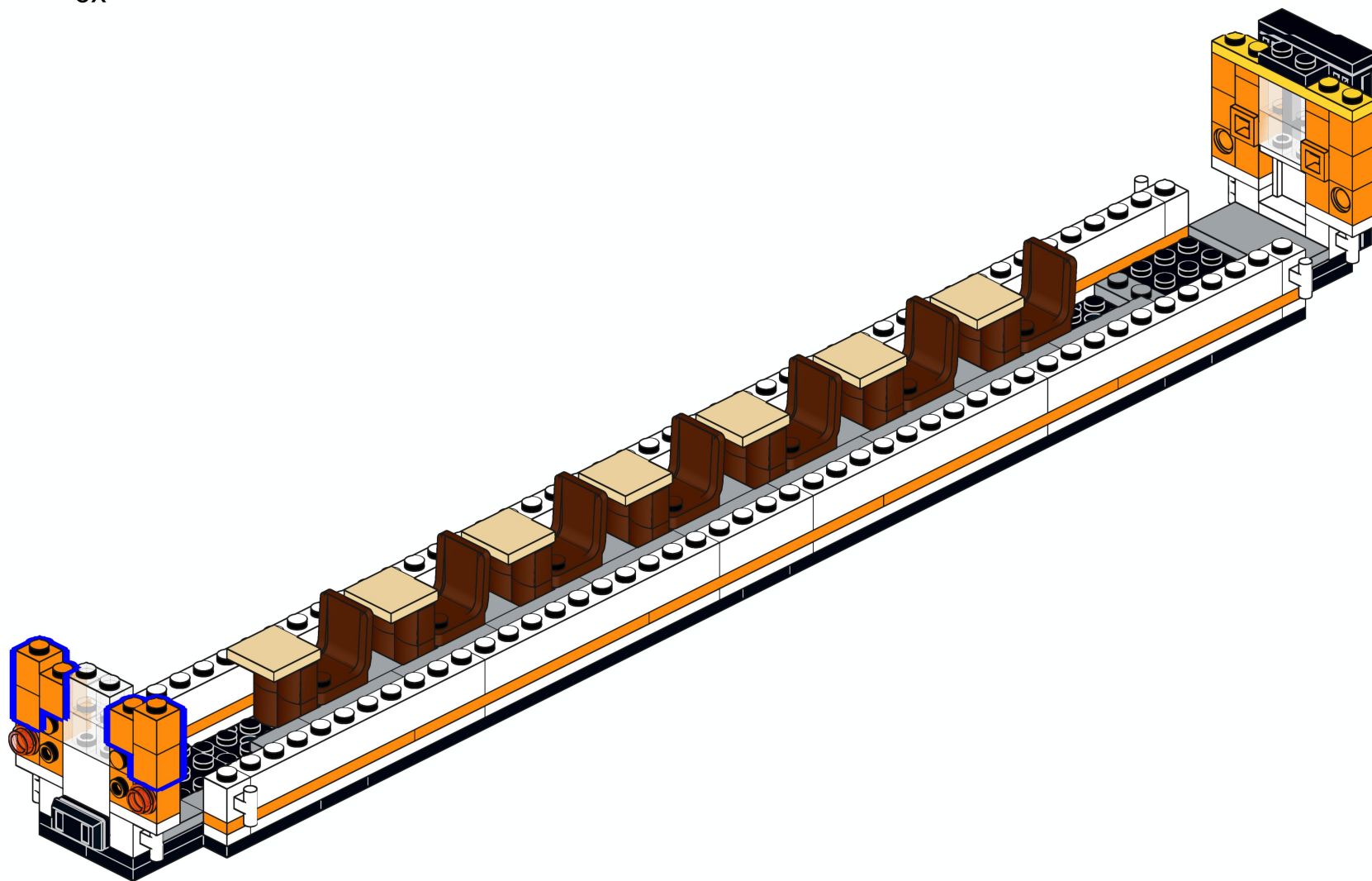

# 28

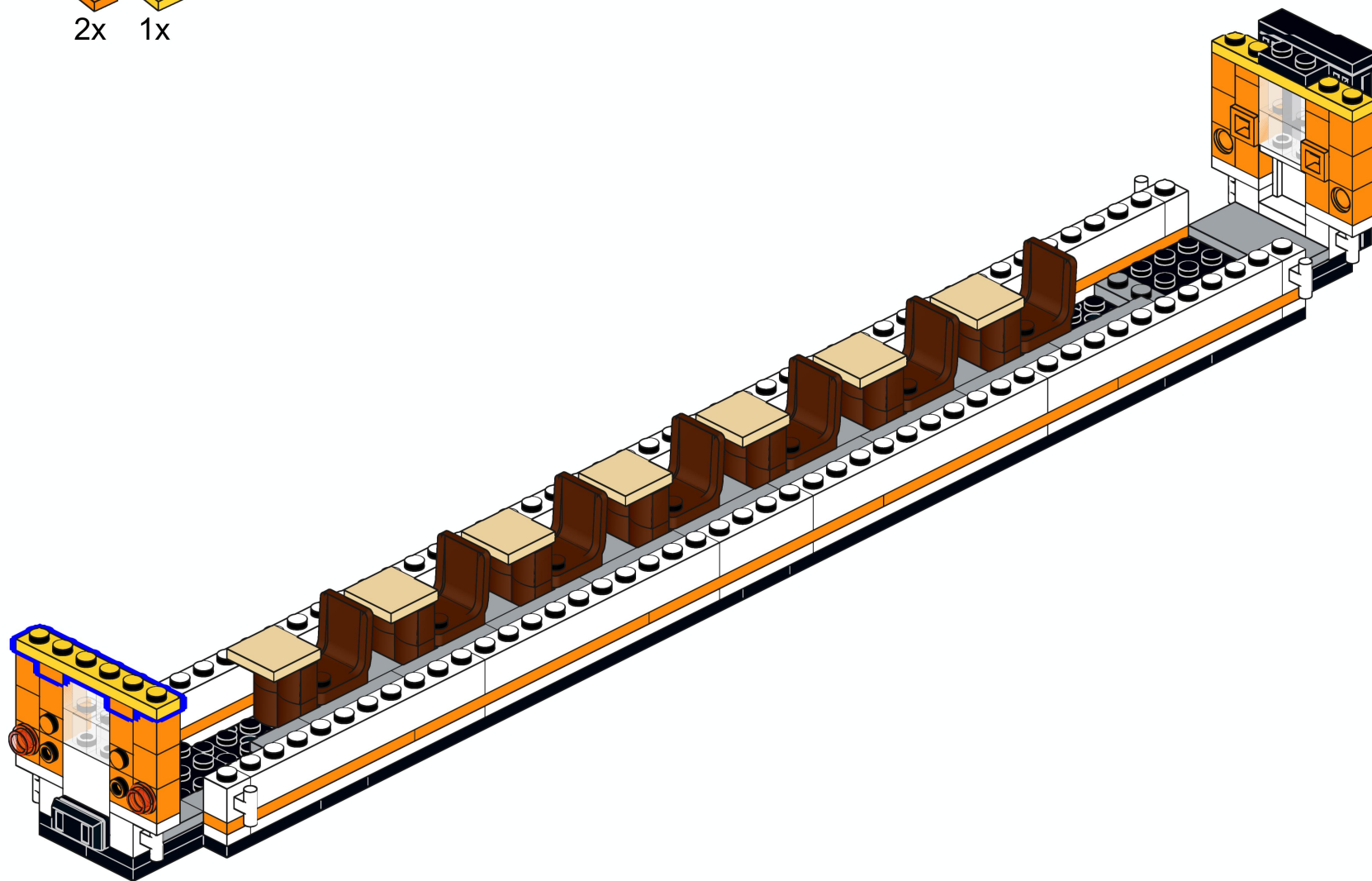
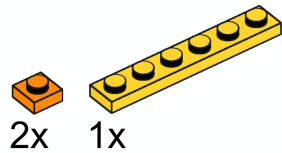

# 29

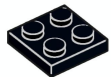

1x

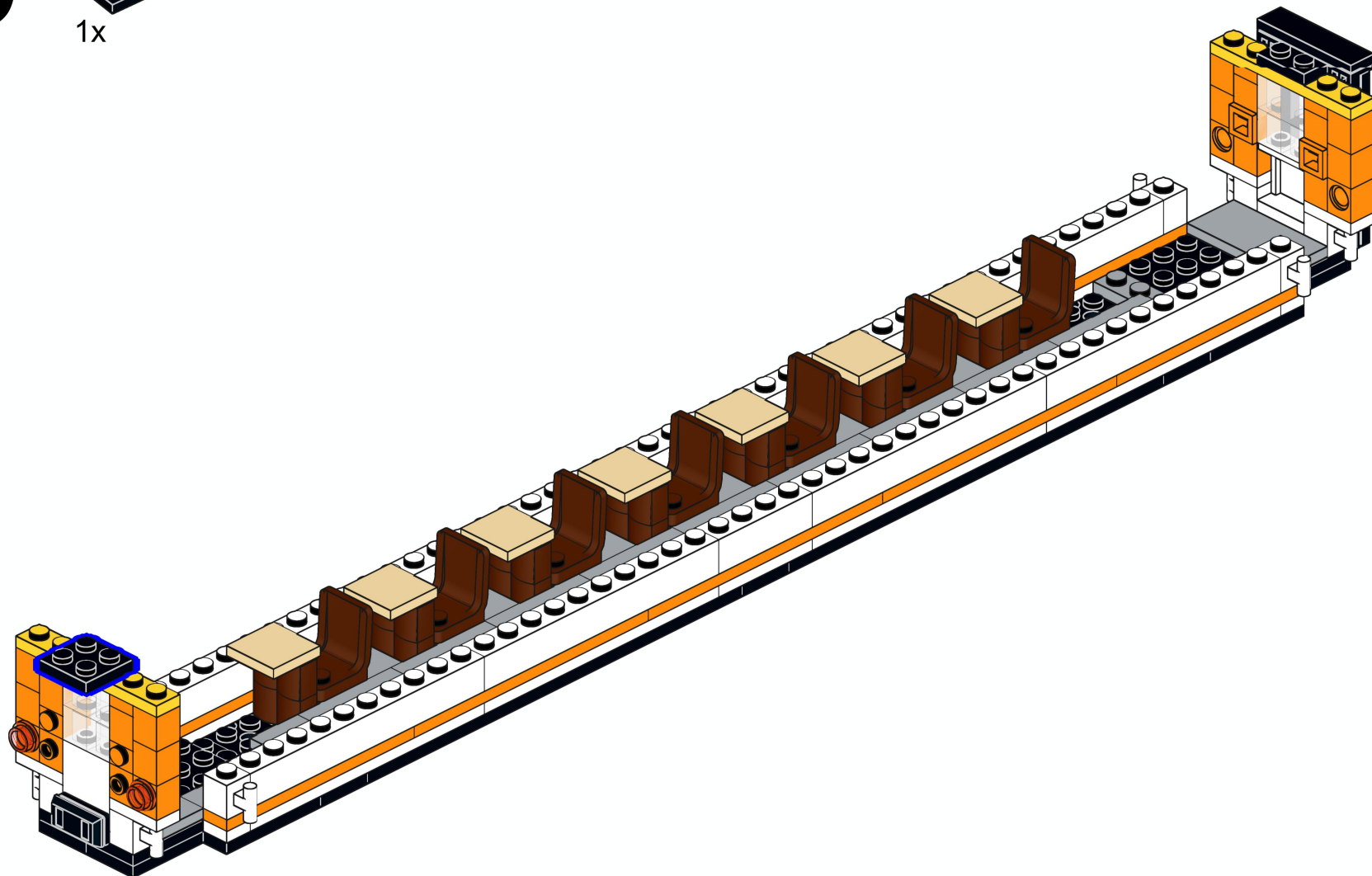

# 30



2x



2x



2x



2x

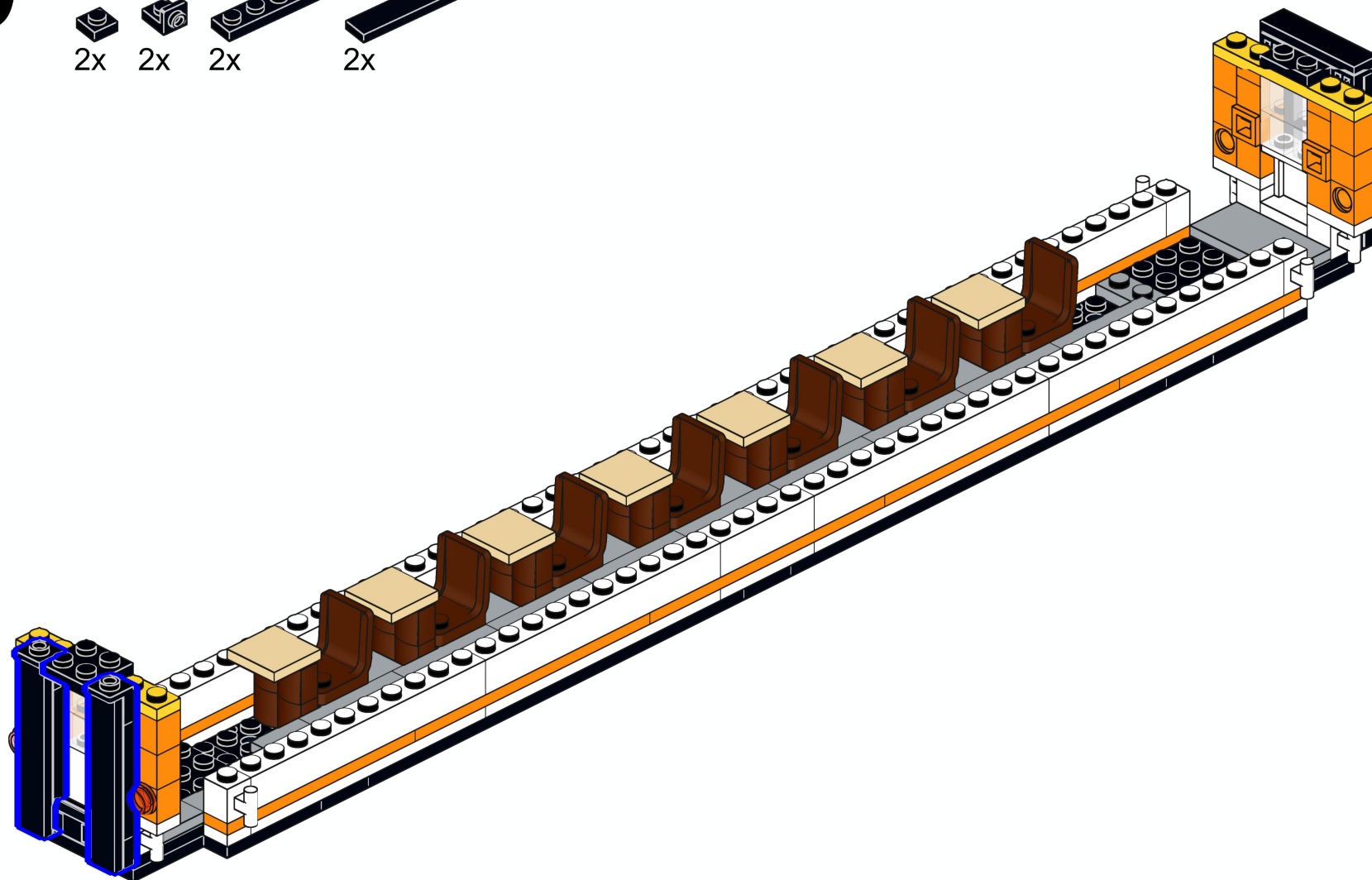

# 31

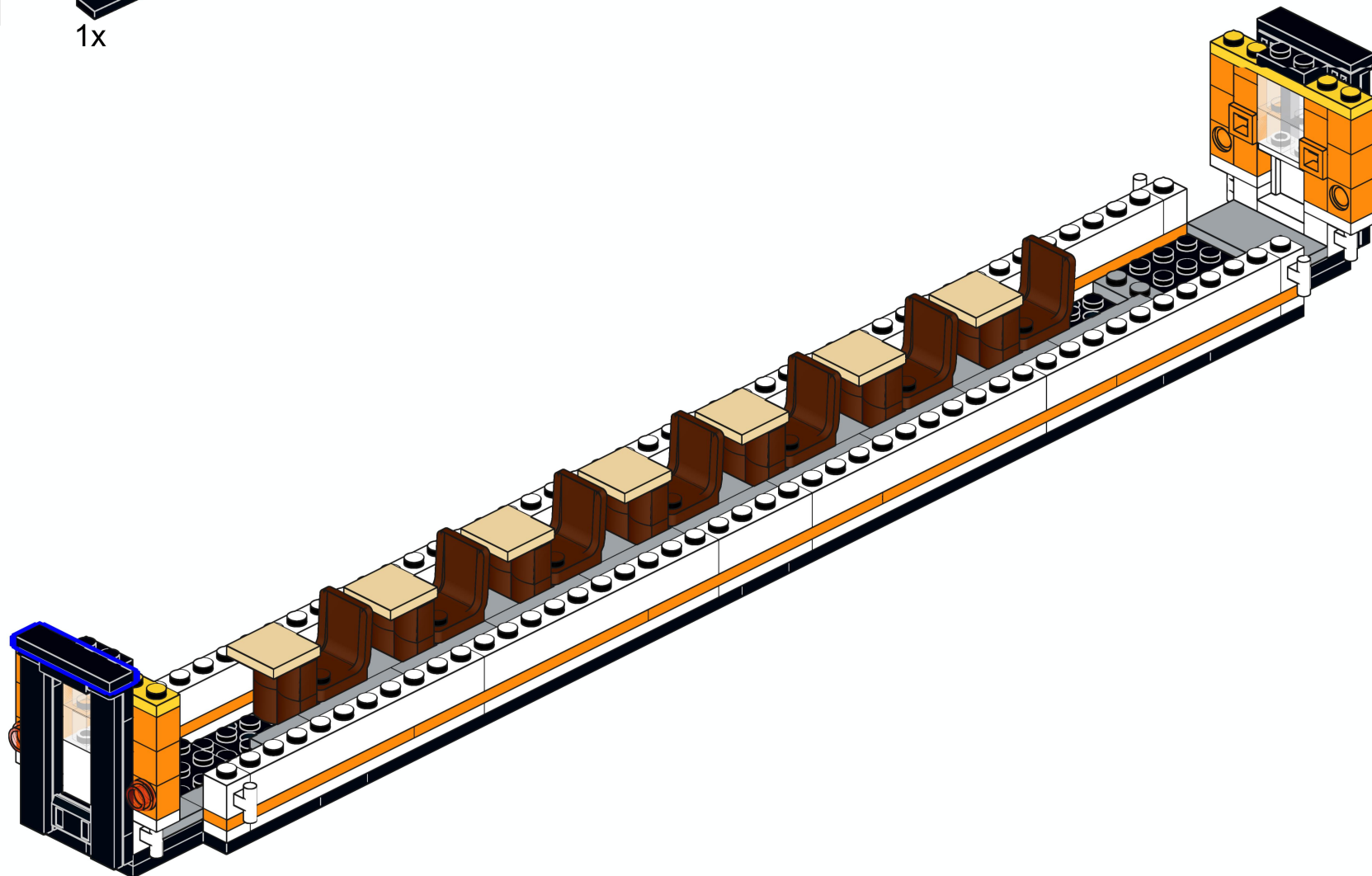
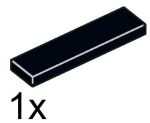

# 32

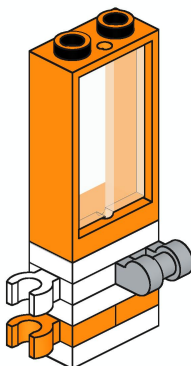
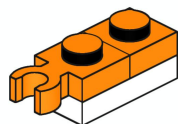

# 34

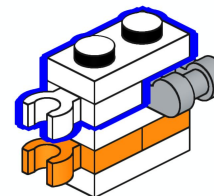
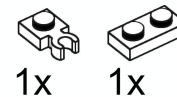

# X2

# 33

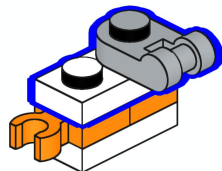
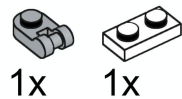

# 35

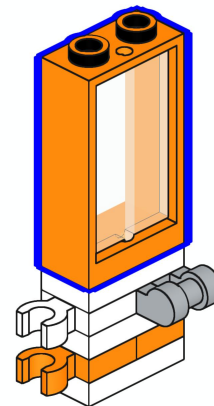
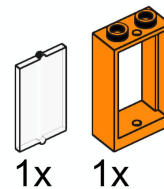



# 36

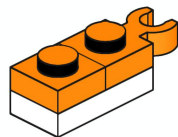
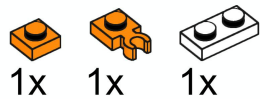

# 38

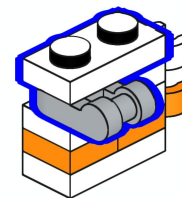
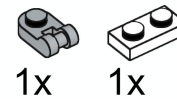

# X2

# 37

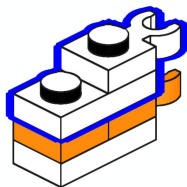
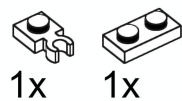

# 39

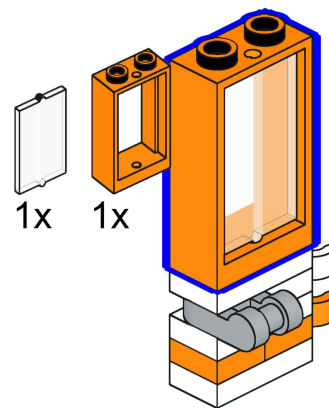

# 40

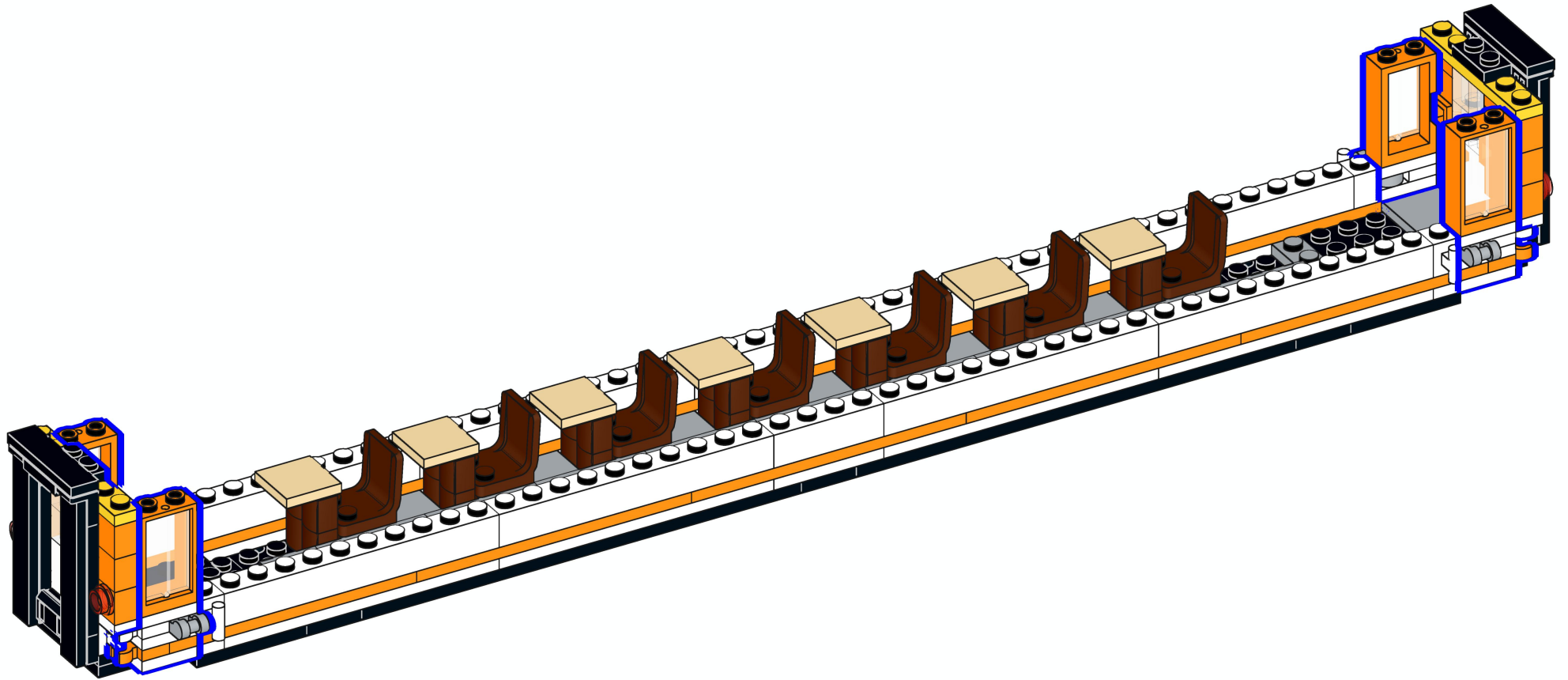

# 41



4x

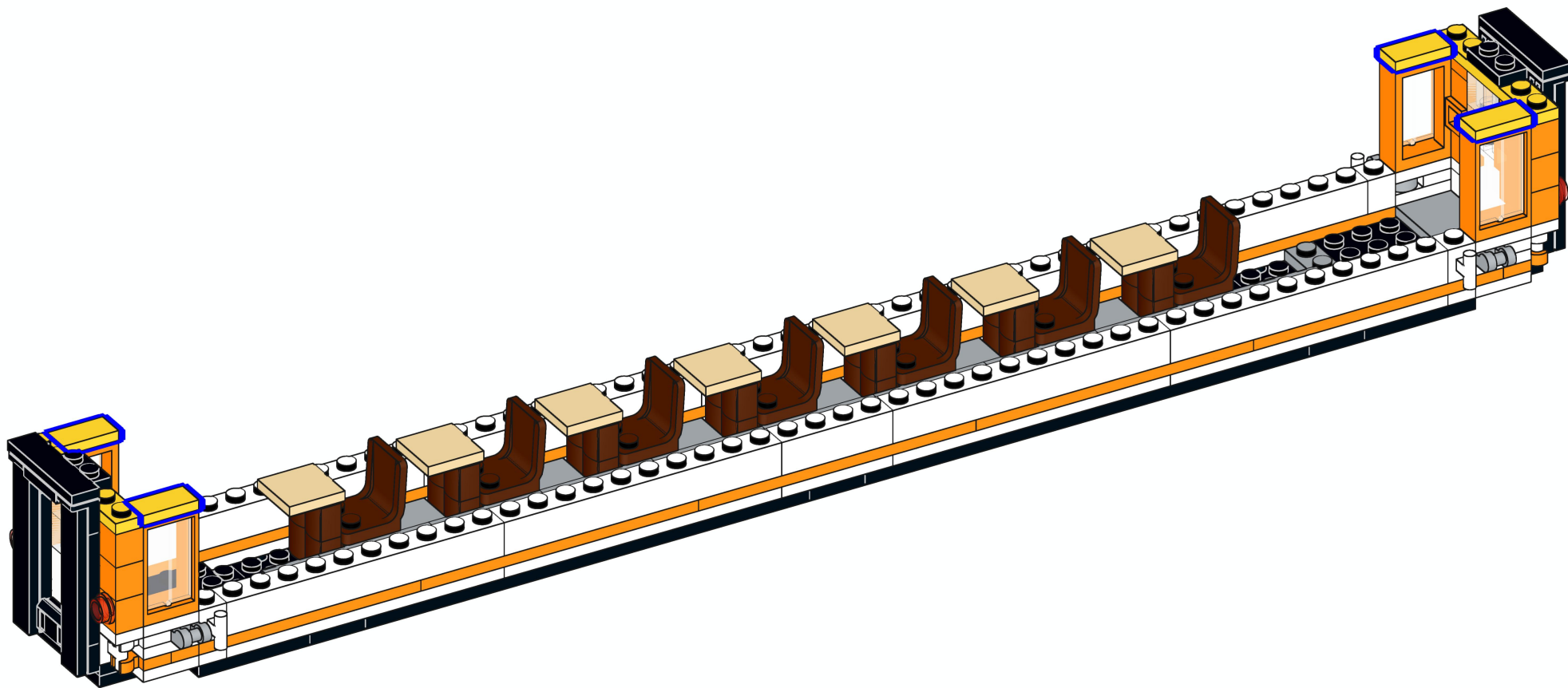

# 42

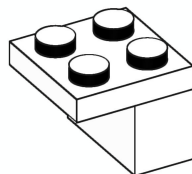
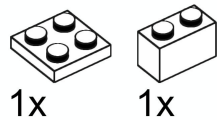

# 44

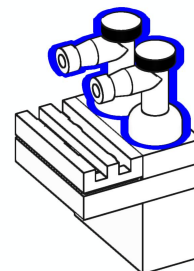

# X2

# 43

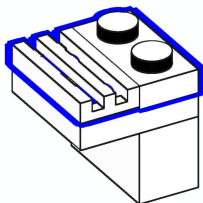
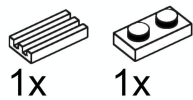

# 45

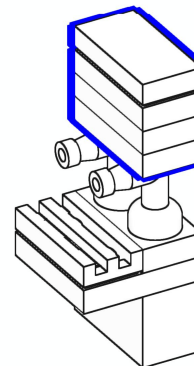
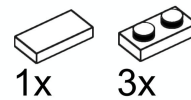

# 46

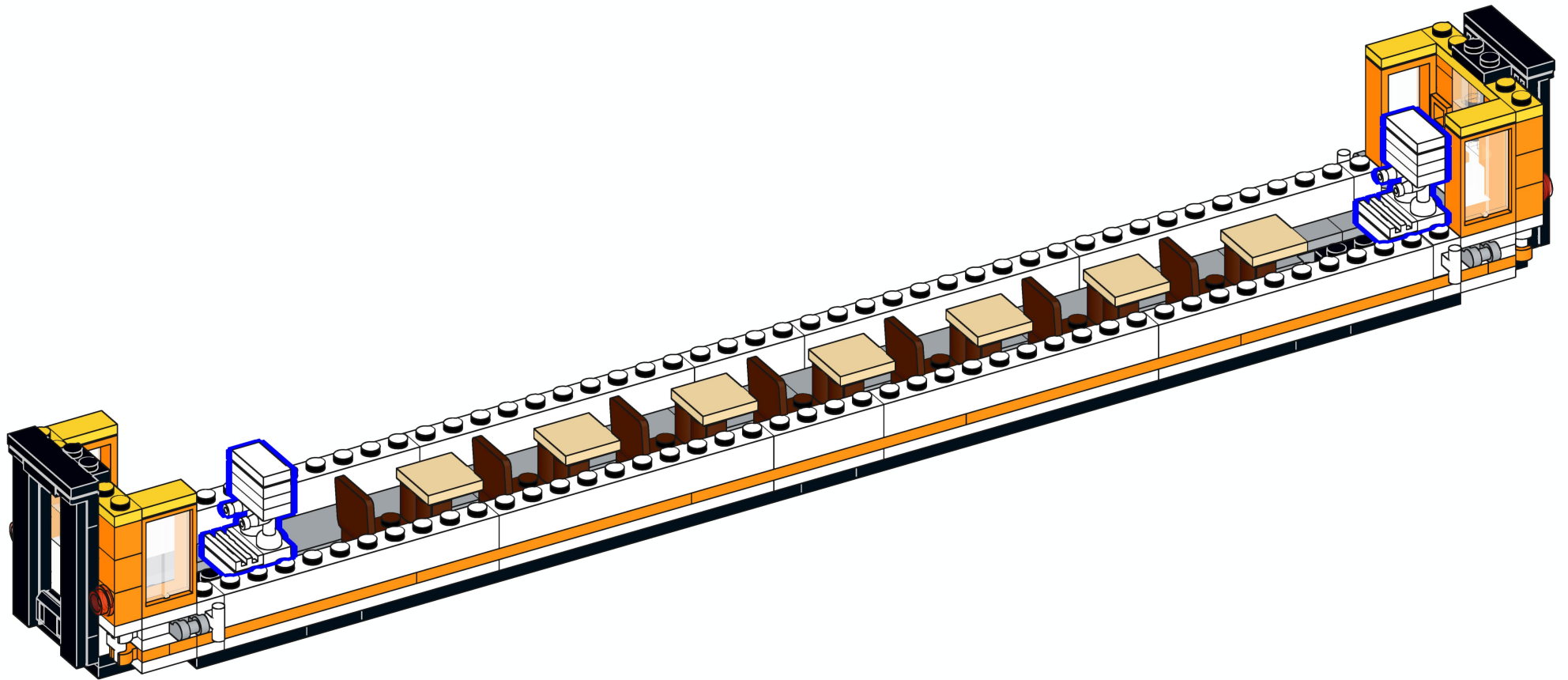

# 47

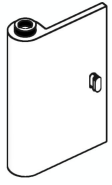

4x

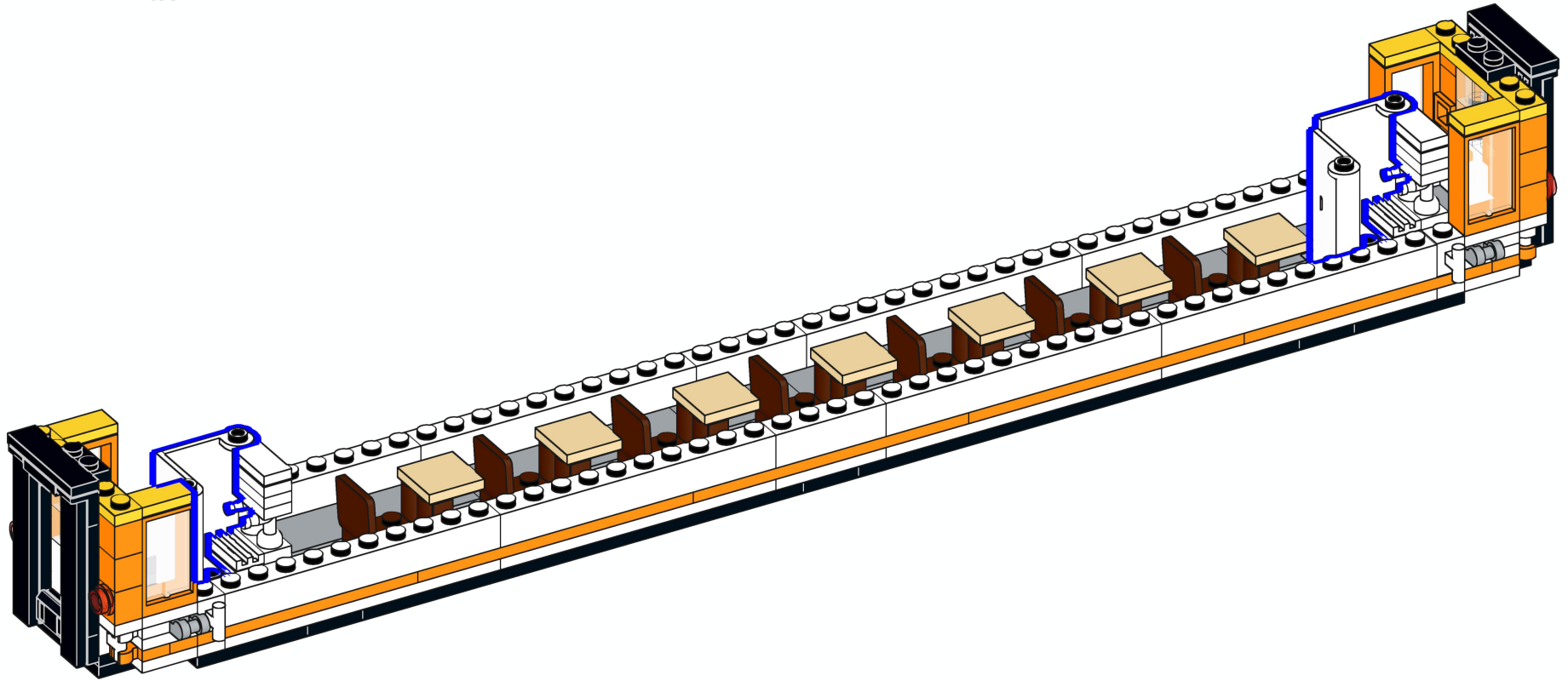

# 48

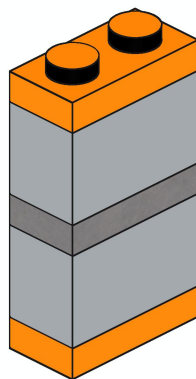
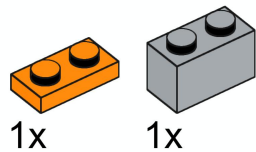

# 49

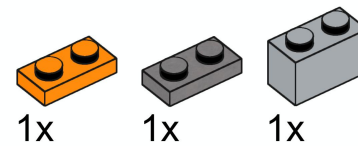

# X2

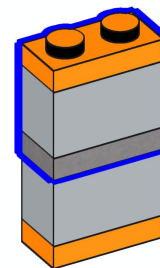
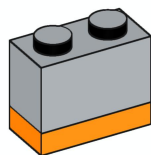



# 50

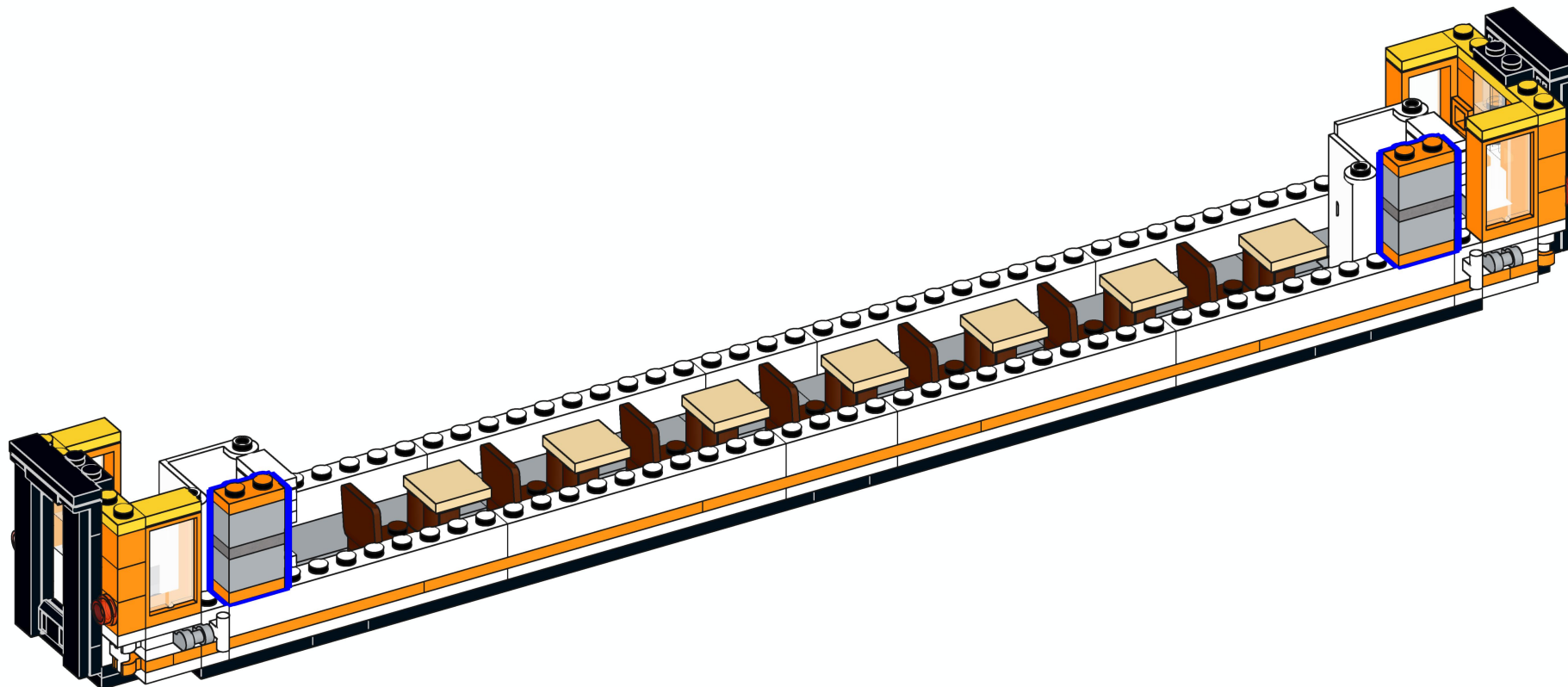

# 51

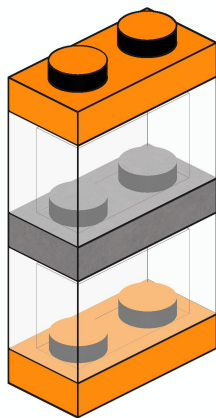
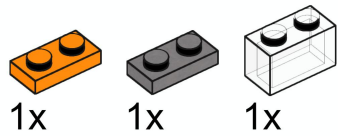

# 52

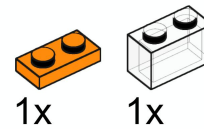

# X2

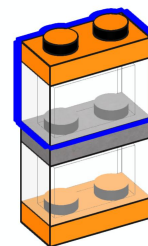
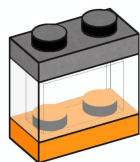

# 53

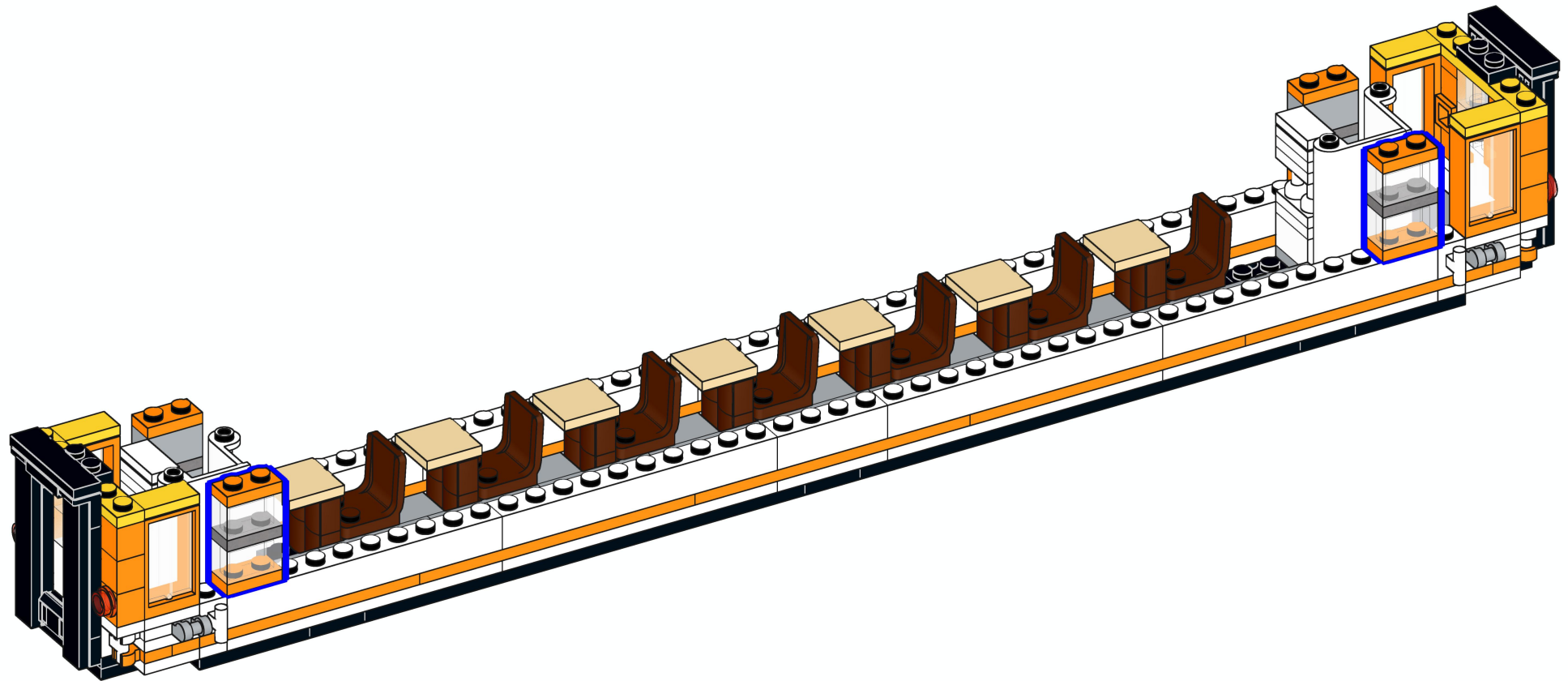

# 54



4x

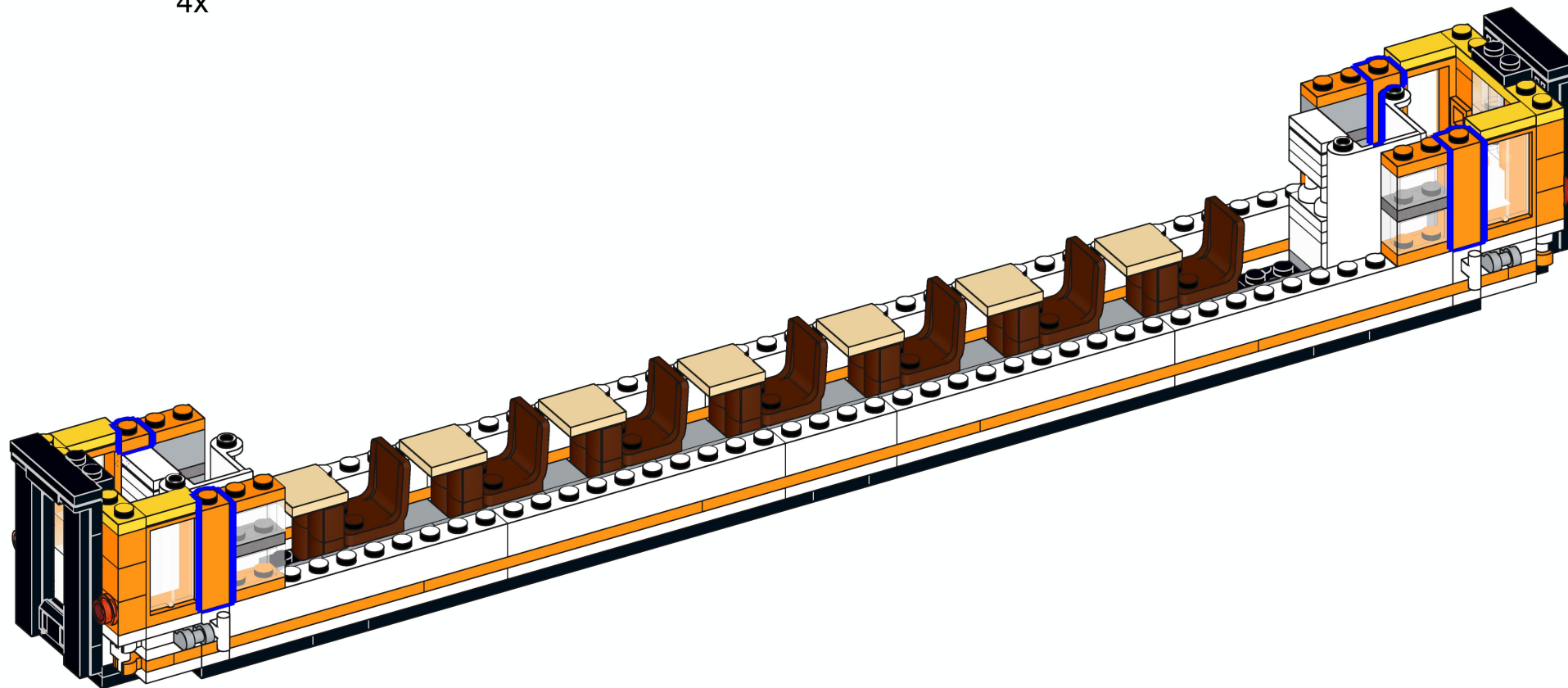

# 55

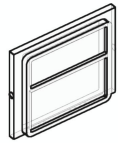

20x

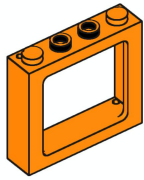

20x

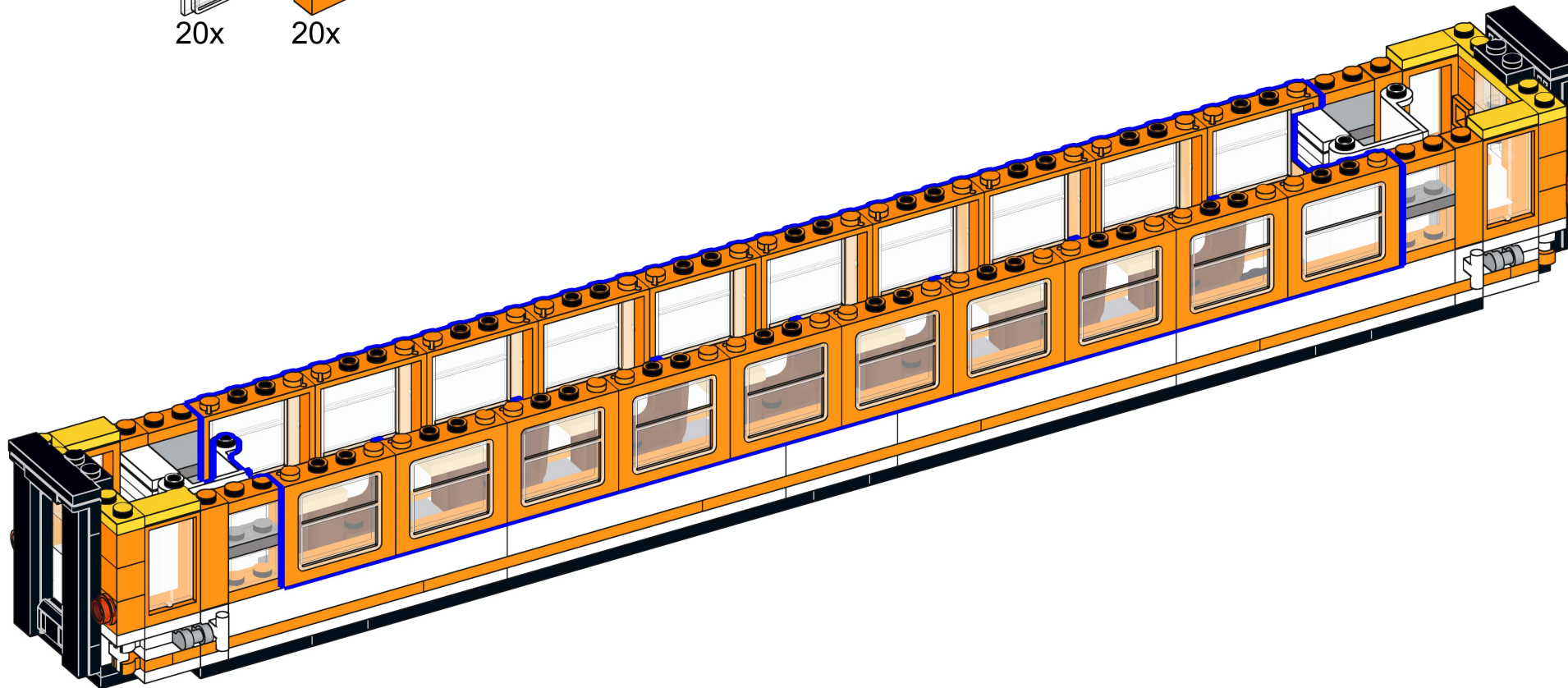

# 56

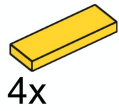

4x

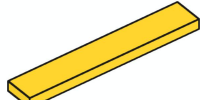

4x

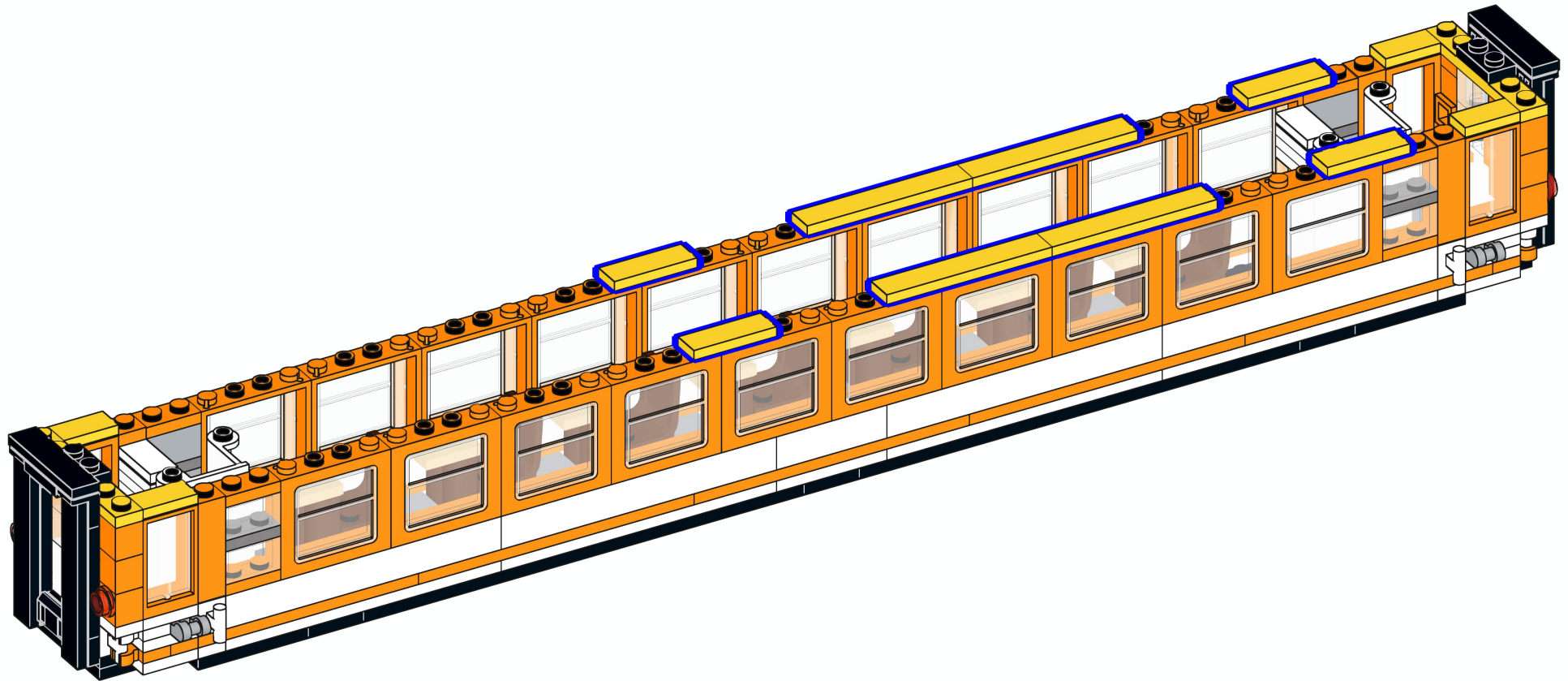



# 57



8x

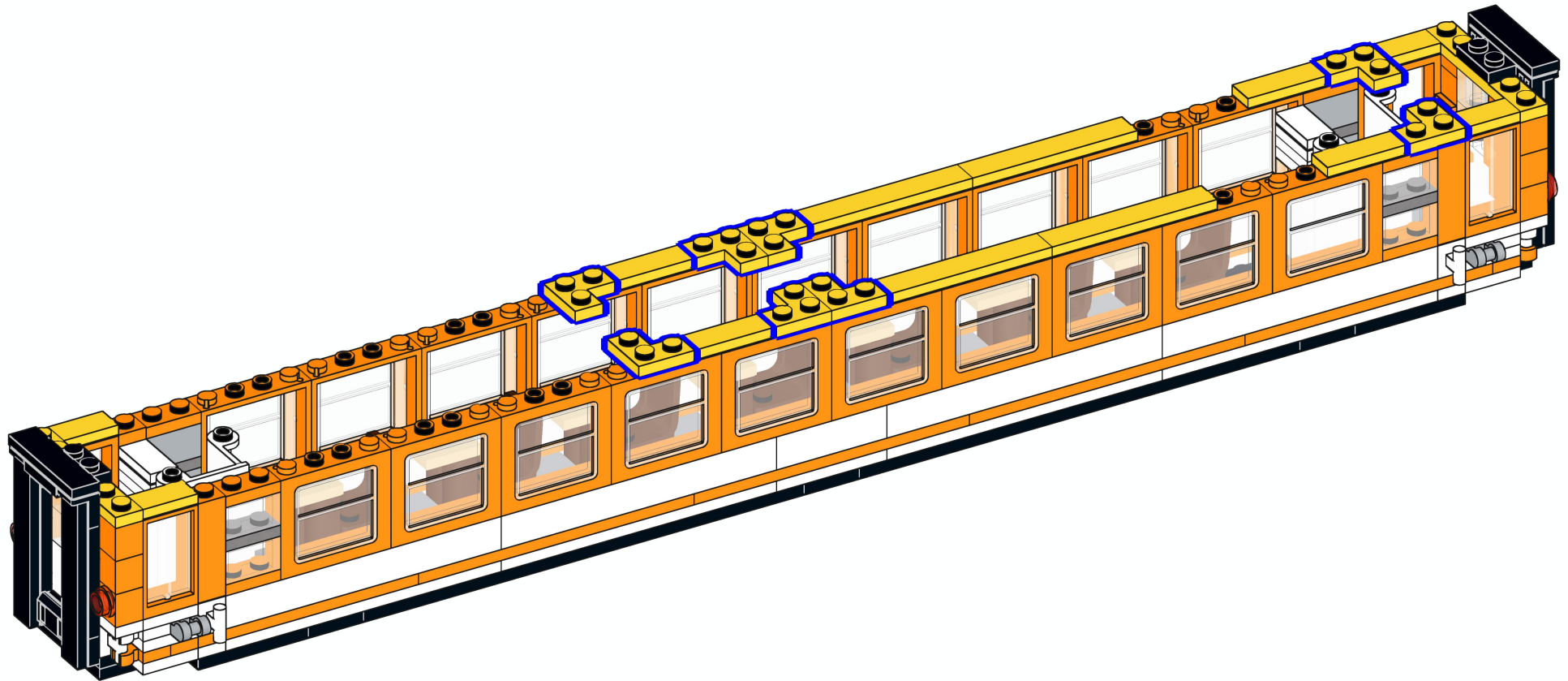



# 58

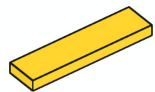

2x

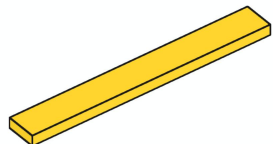

4x

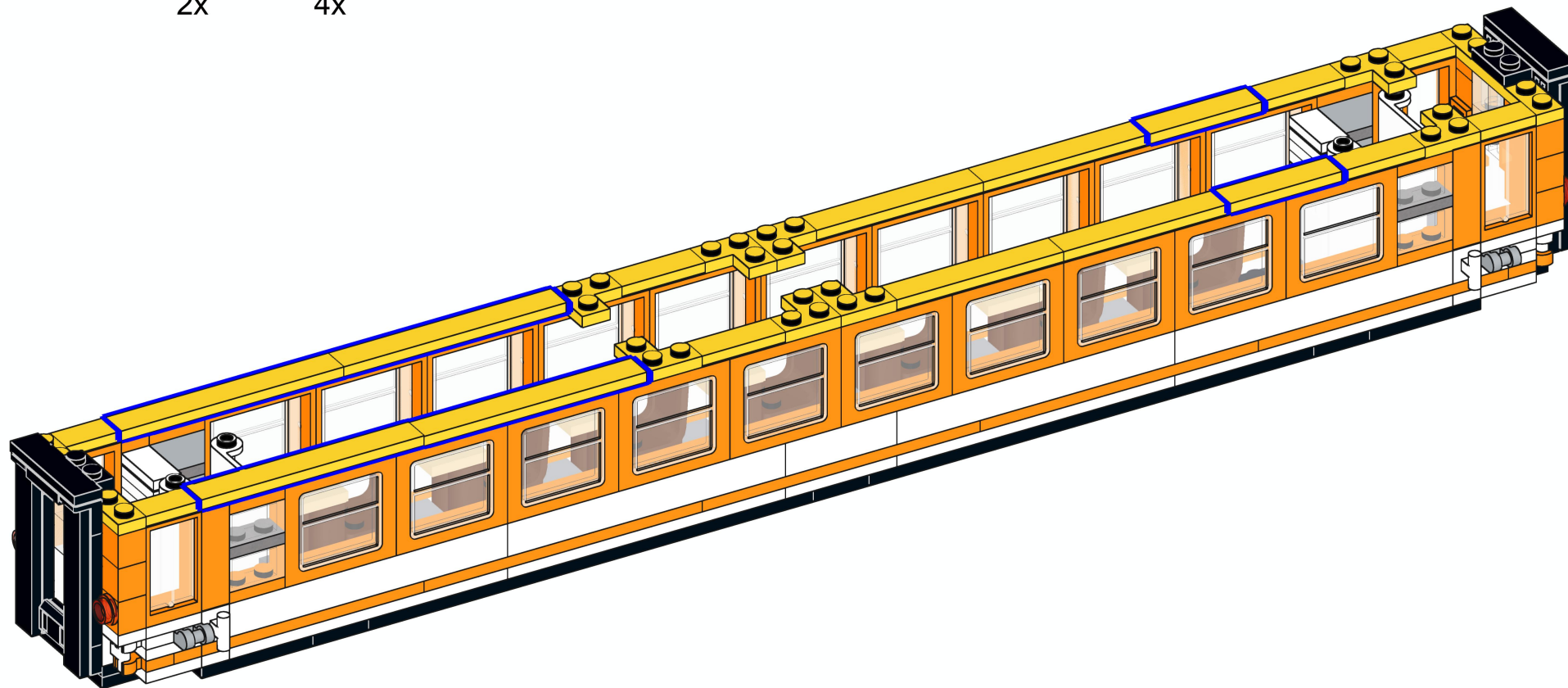

# 59



2x

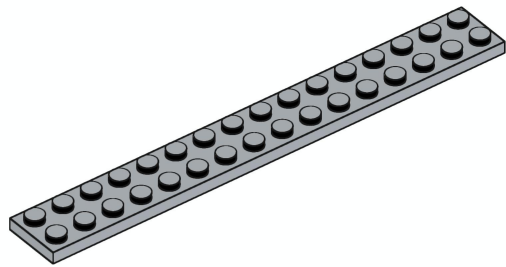

1x

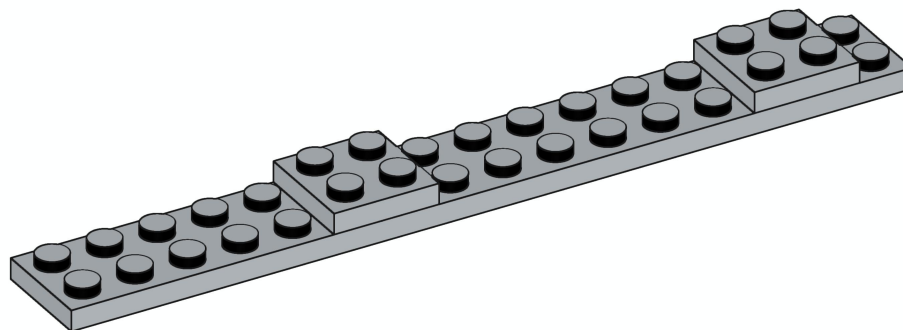
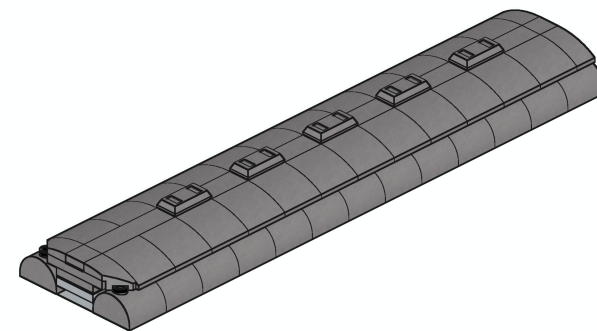

# 60



5x

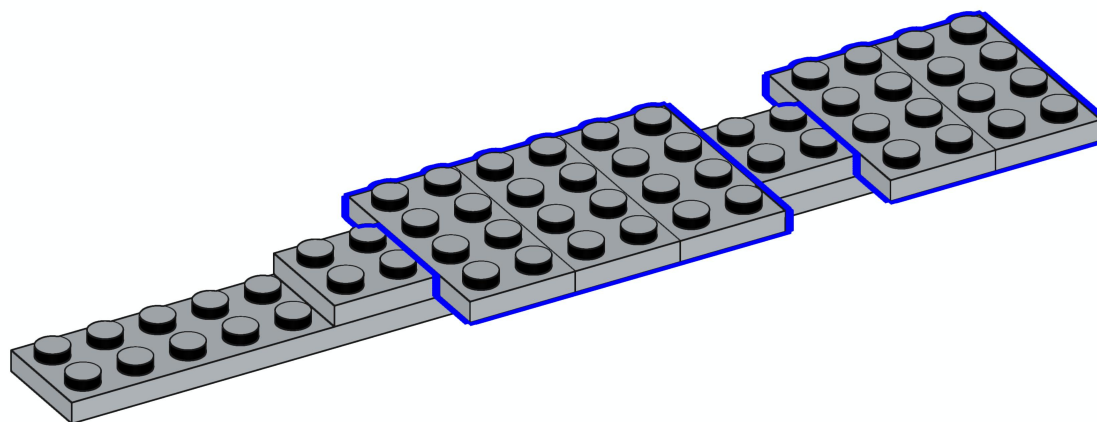

# 61

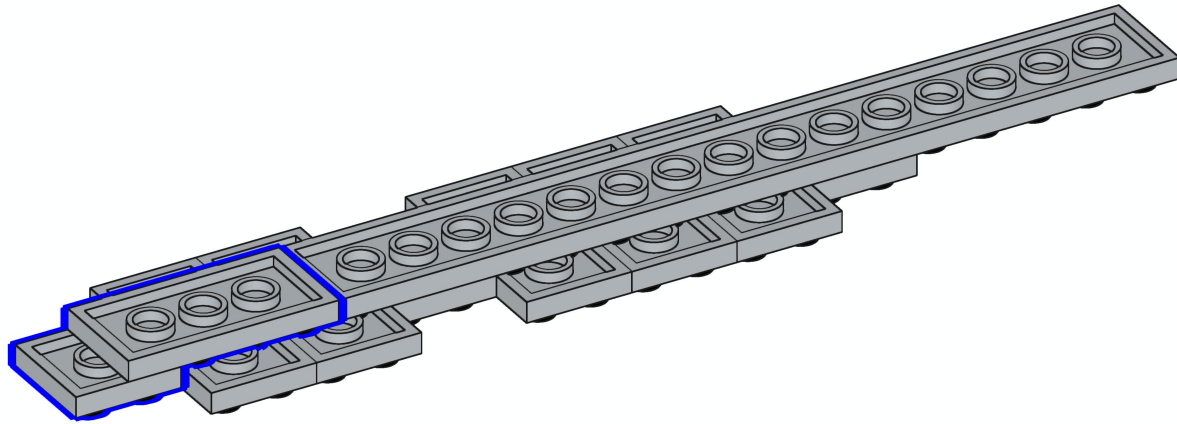
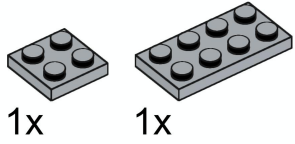

# 62

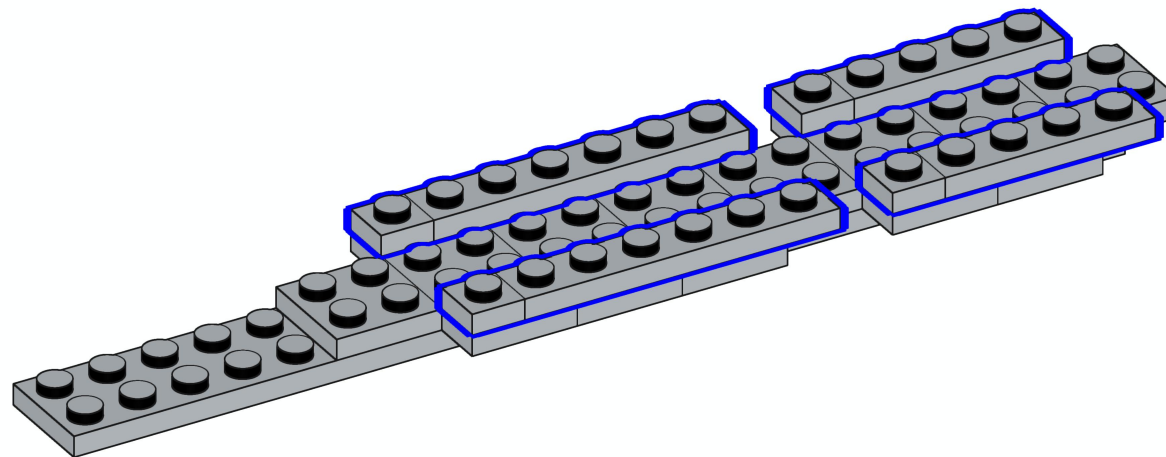
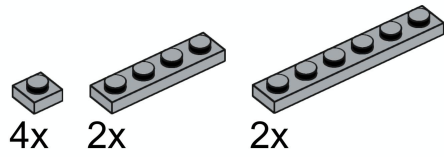

# 63



16x

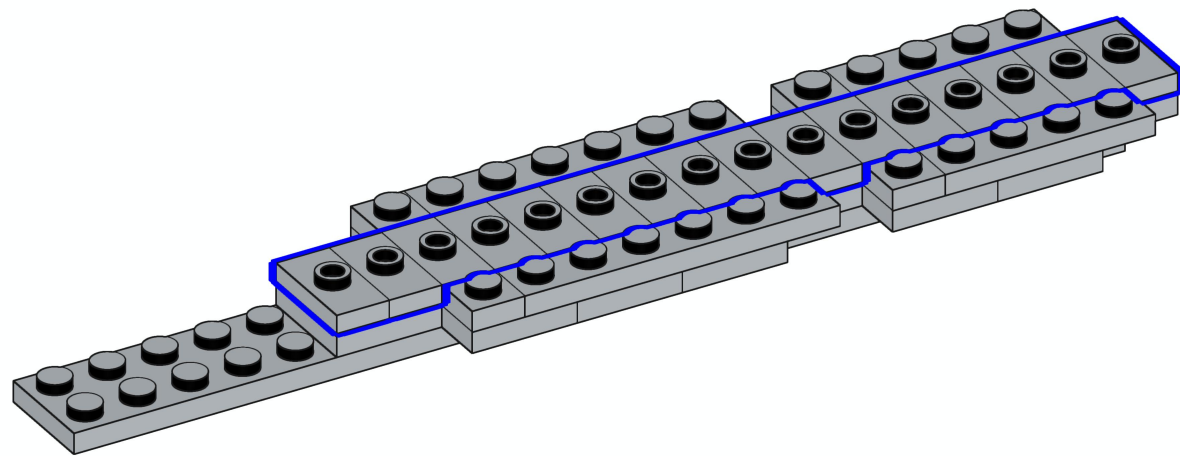

# 64

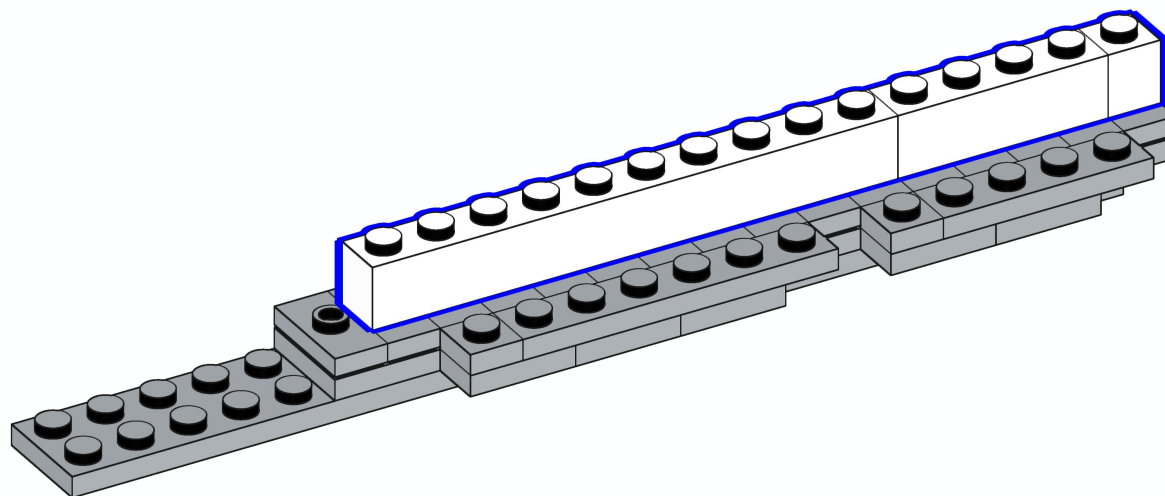
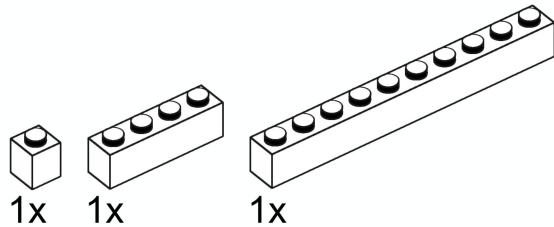



# 65

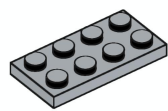

2x

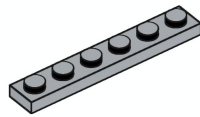

2x

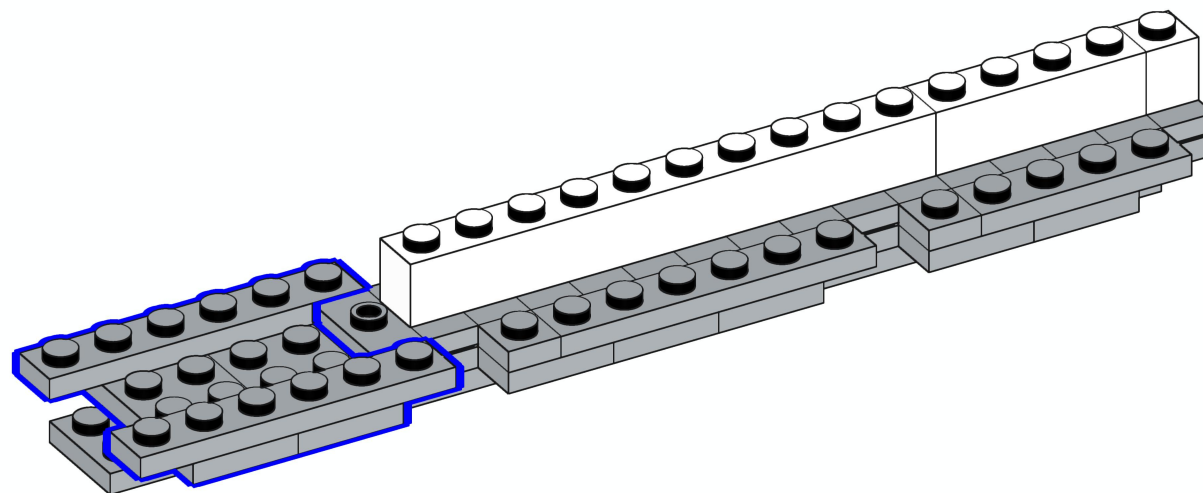

# 66



2x



1x

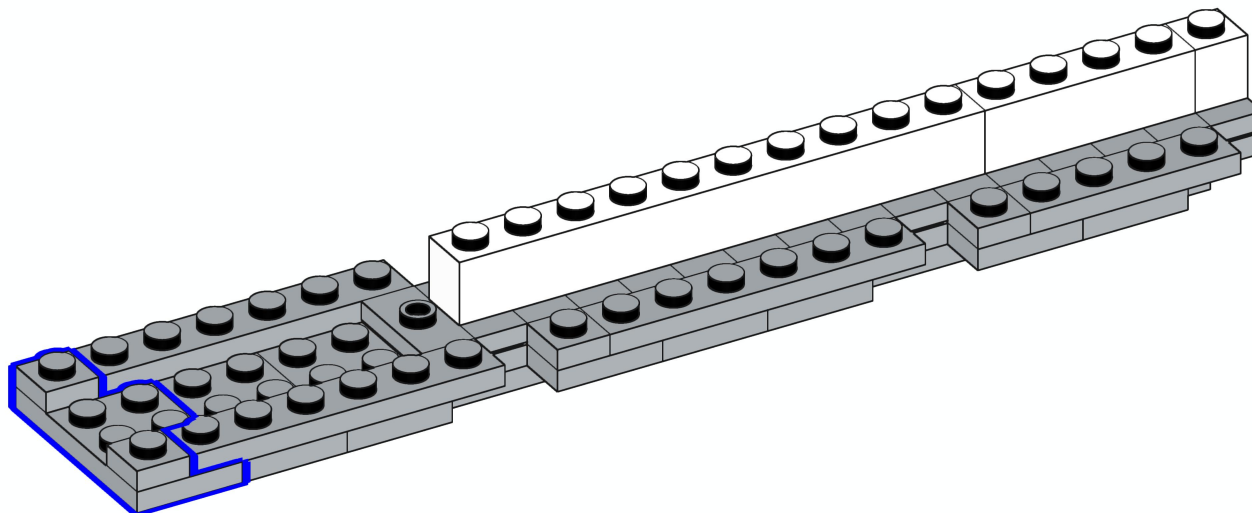

# 67



6x

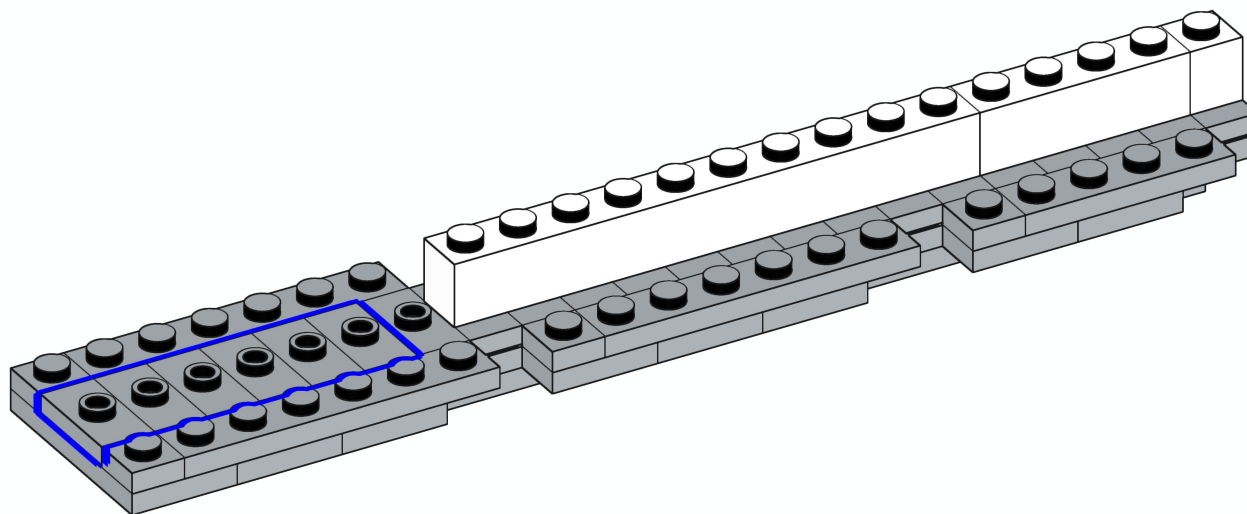

# 68

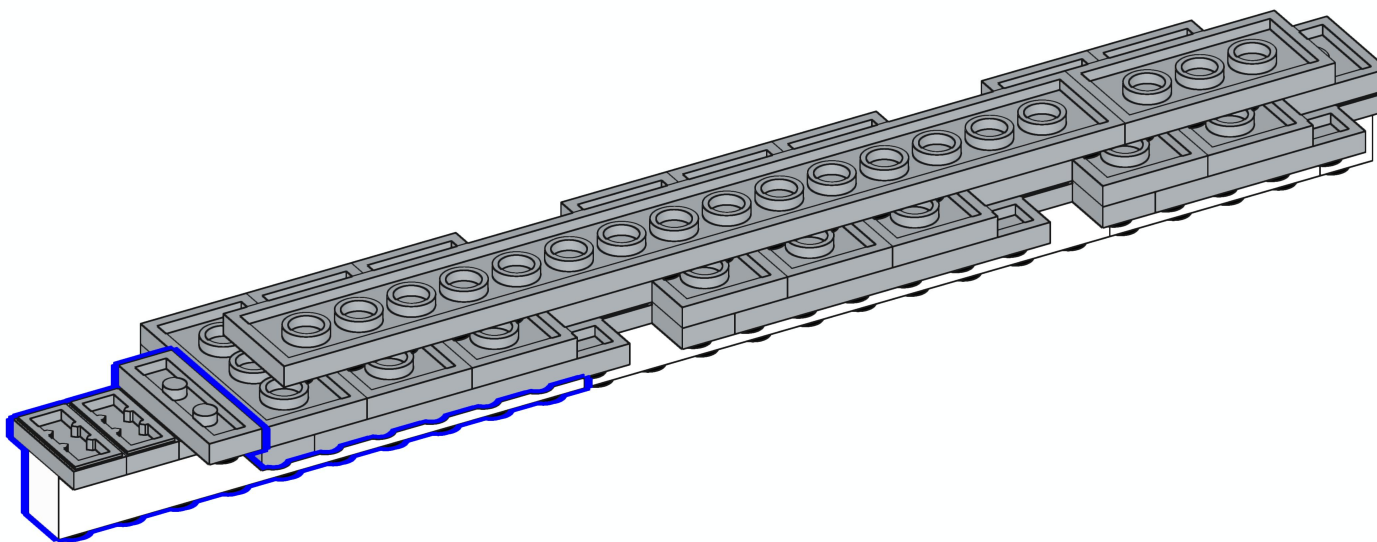
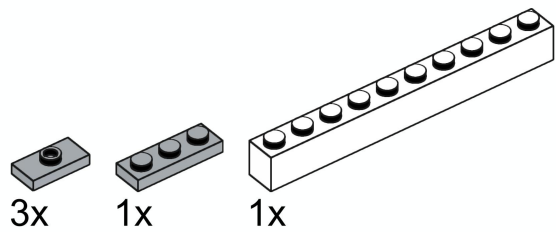

# 69

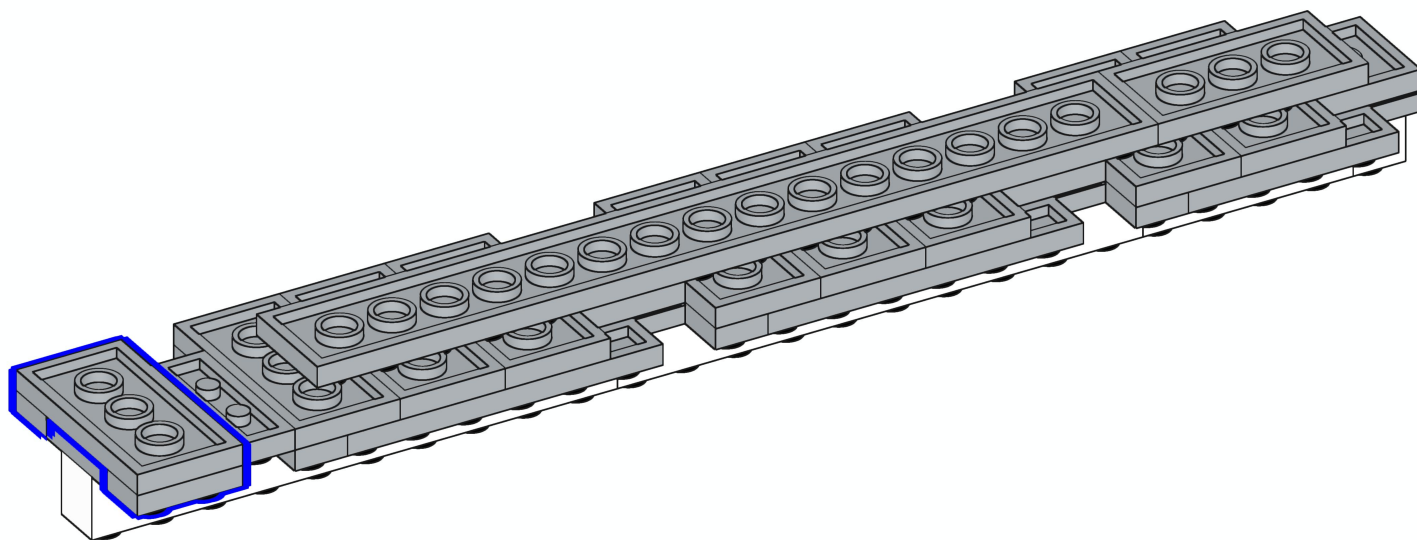
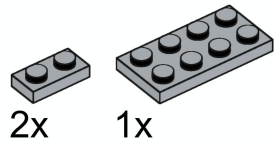

# 70



12x

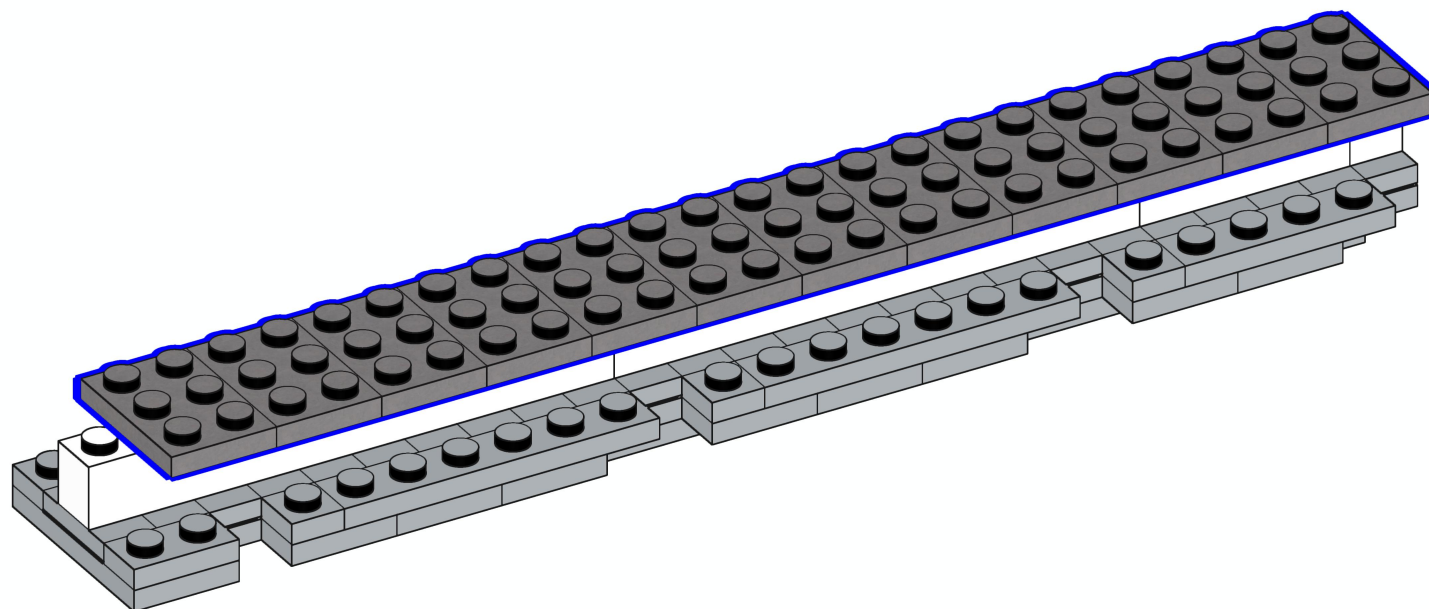

# 71

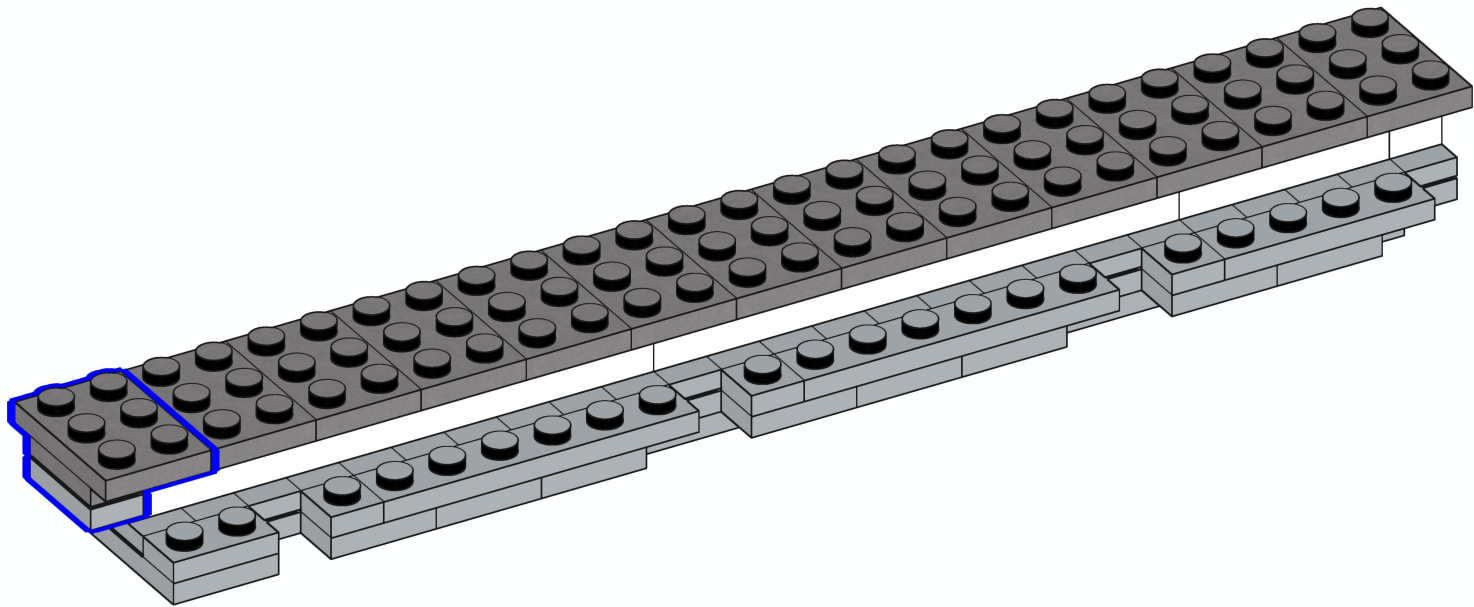
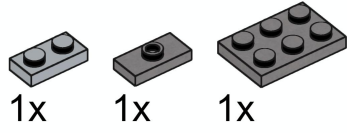



# 72



13x

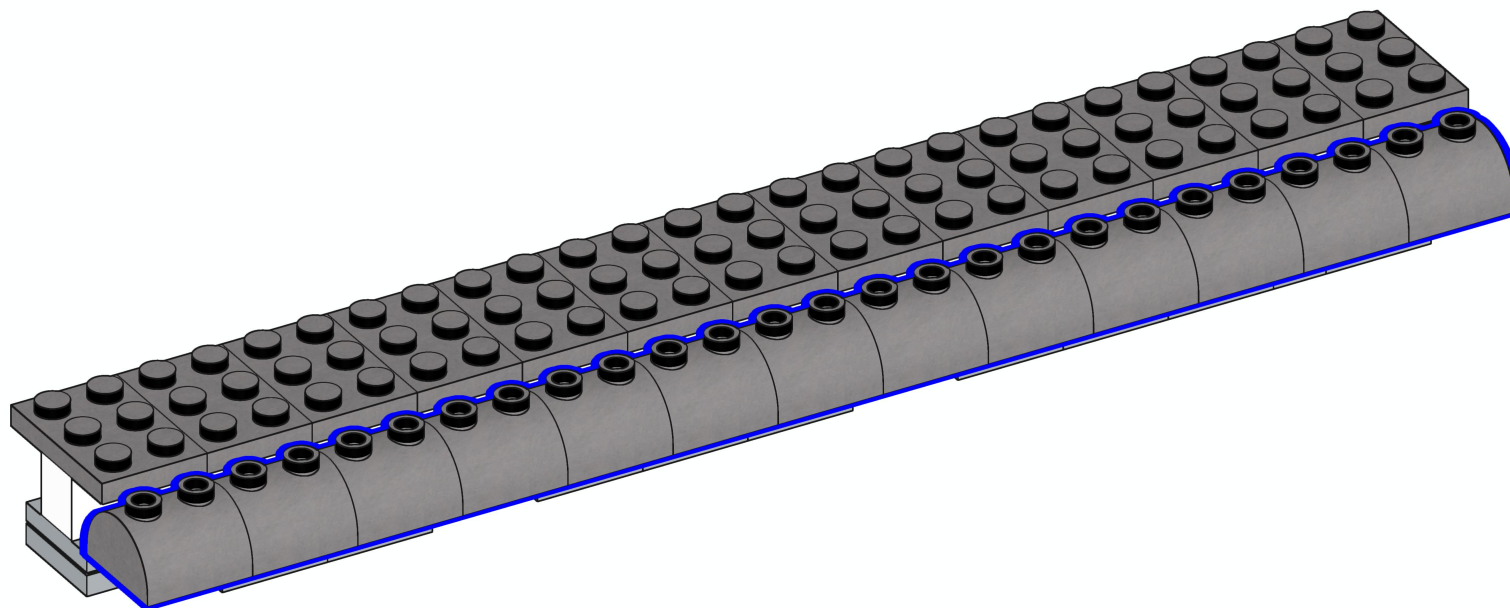

# 73



1x



1x

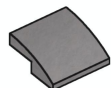

12x

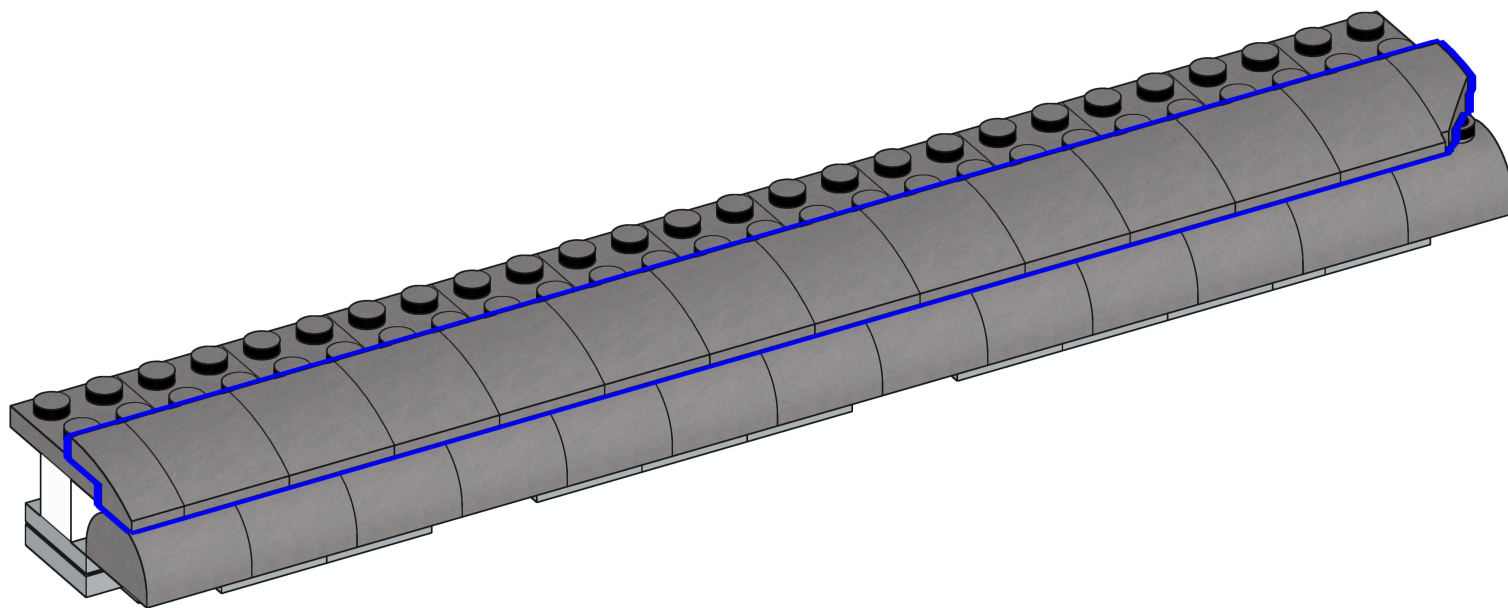

# 74



13x

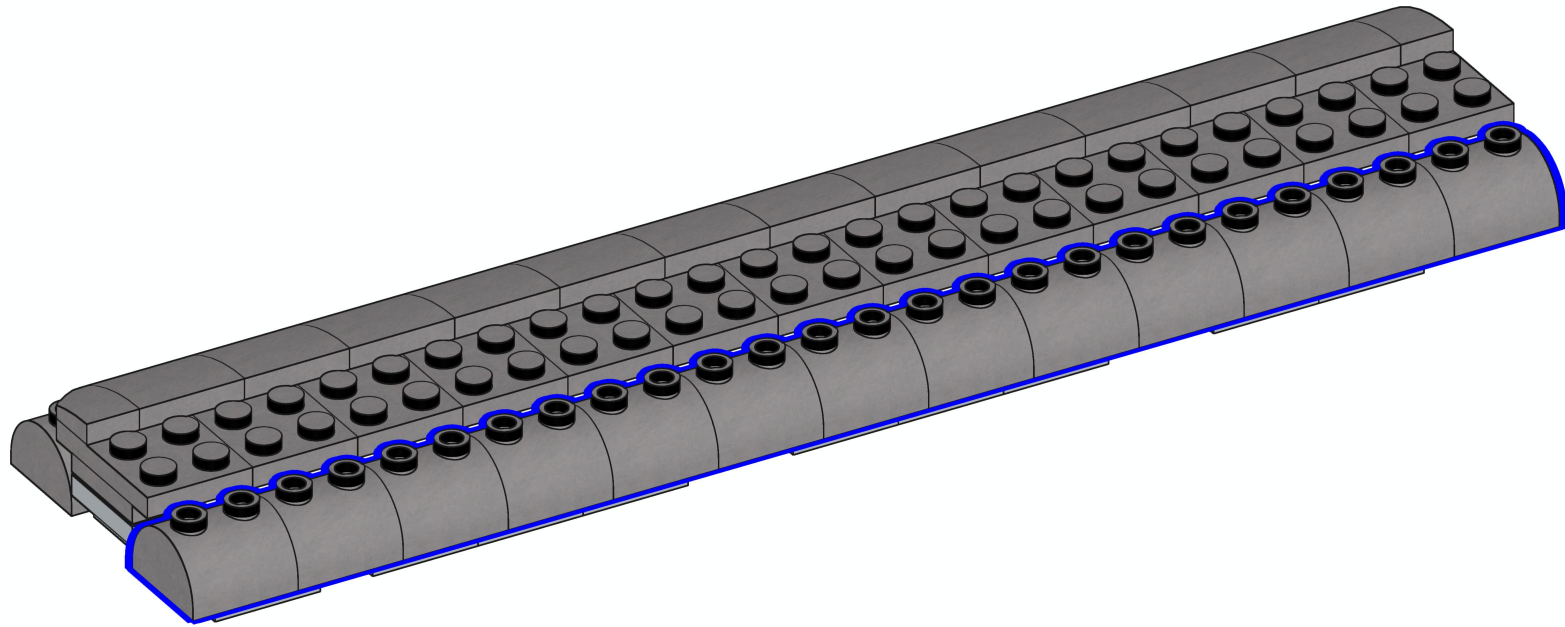

# 75



1x



1x

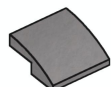

12x

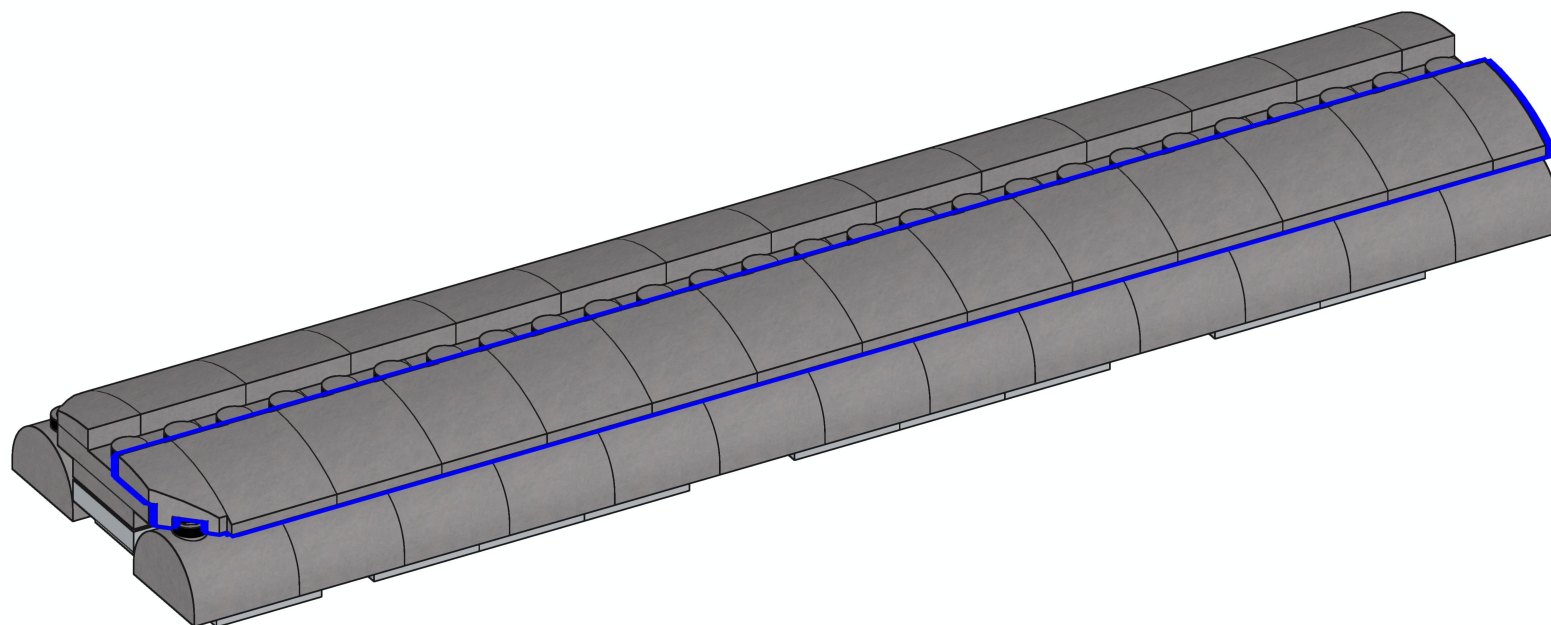

# 76

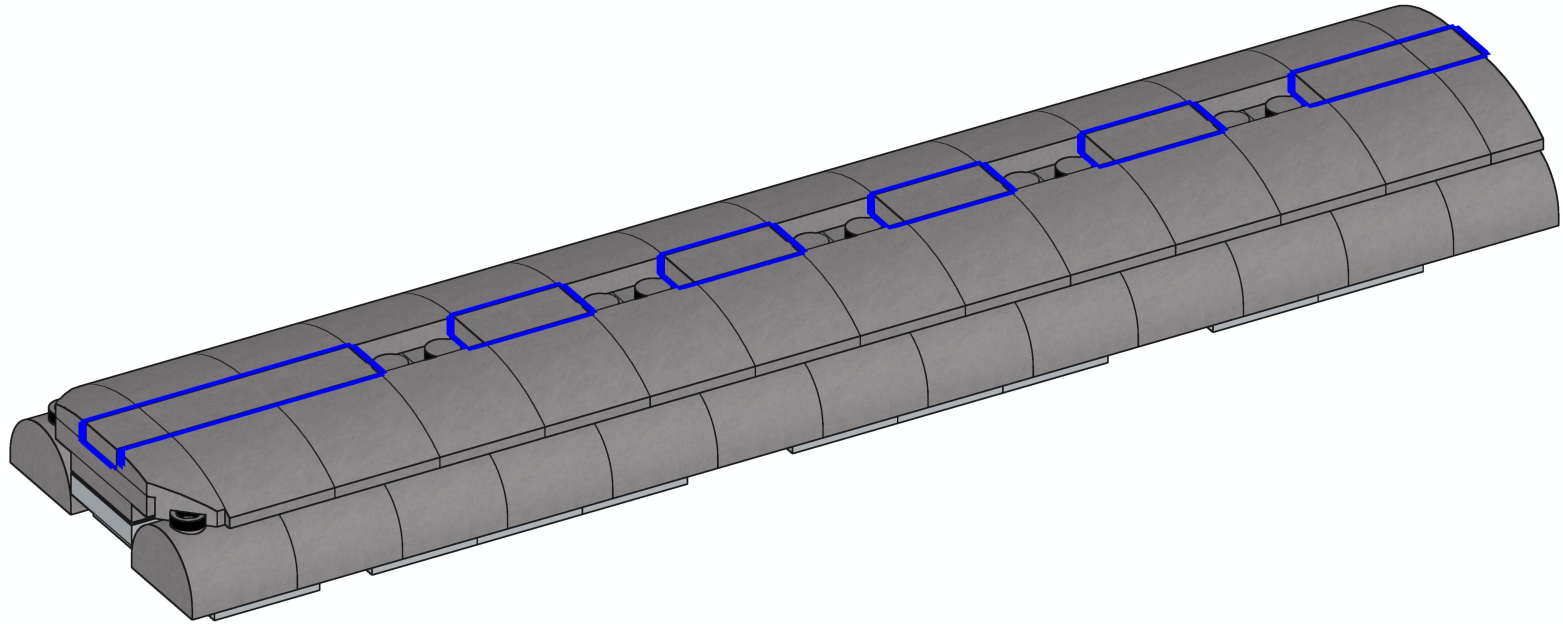
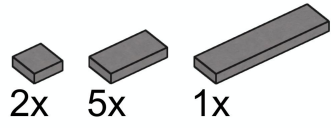

# 77



5x

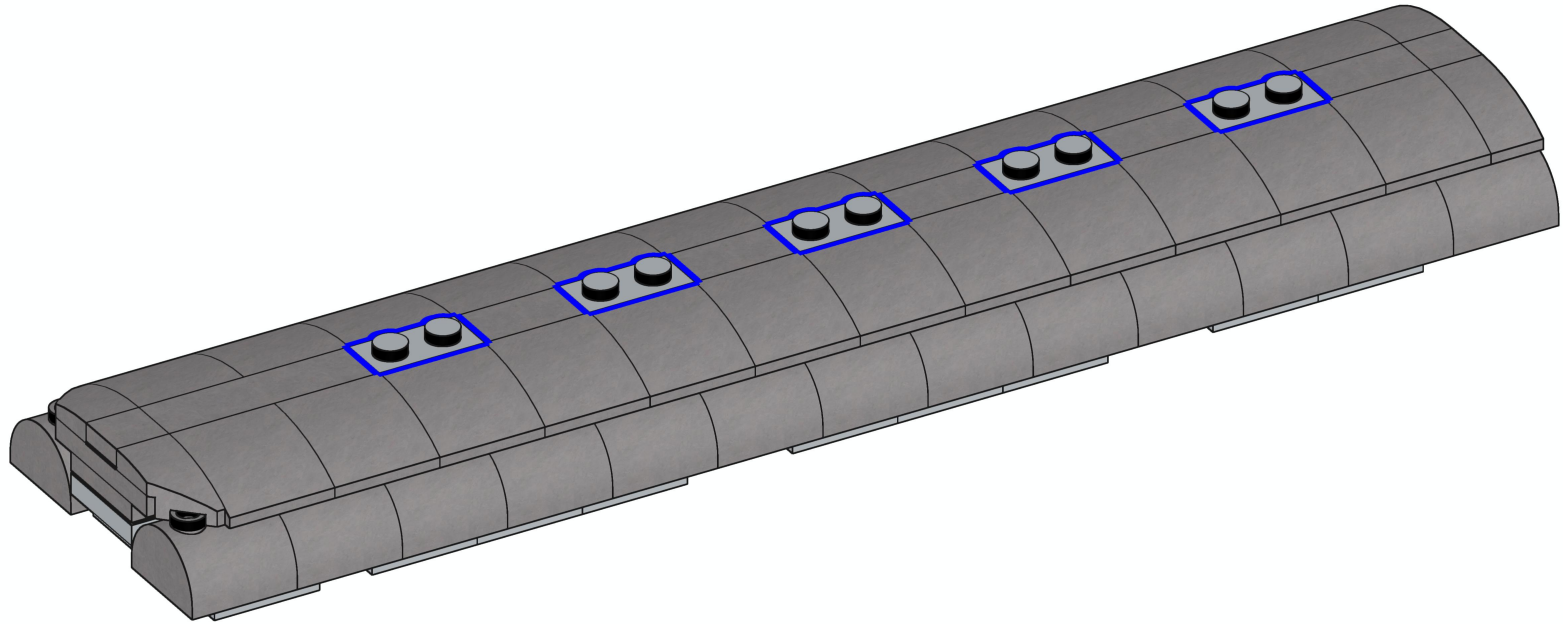

# 78



5x

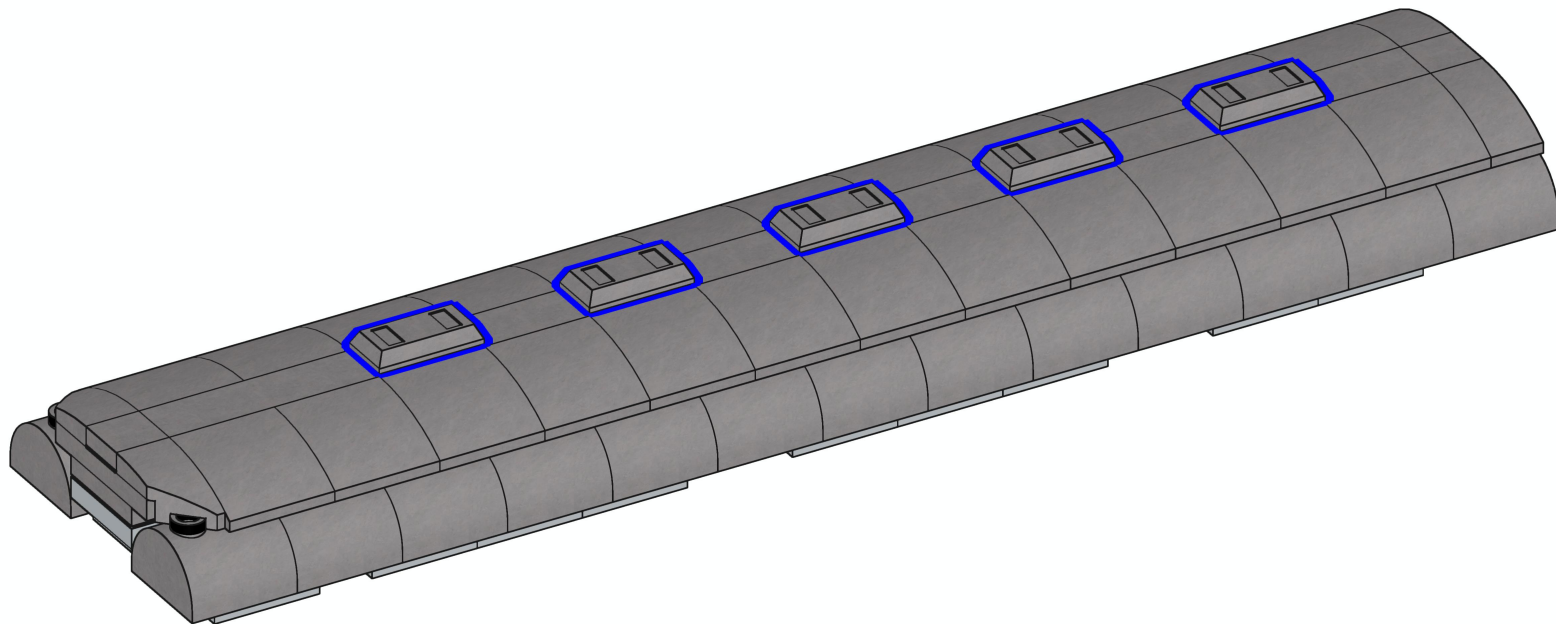



# 79



1x

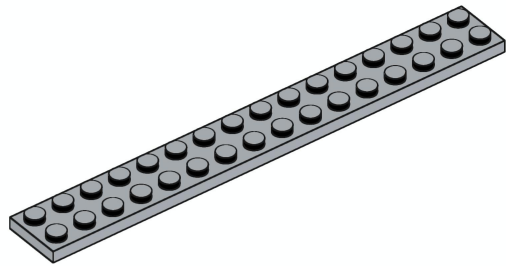

1x

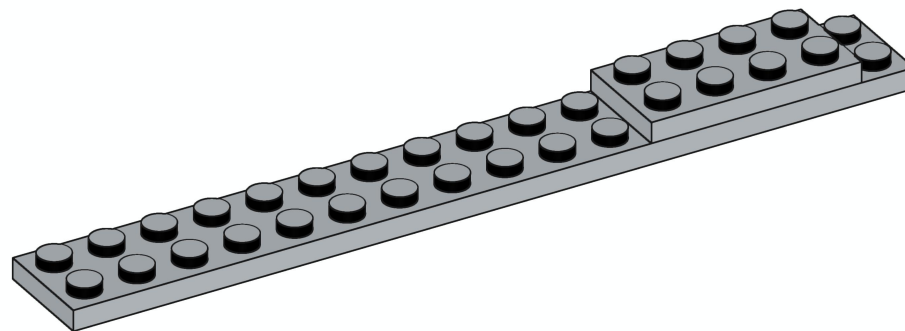
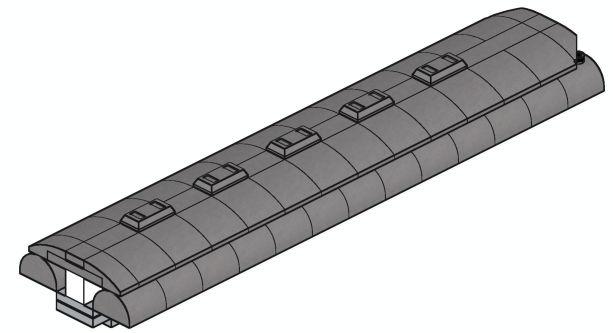

# 80

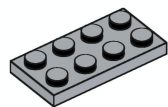

6x

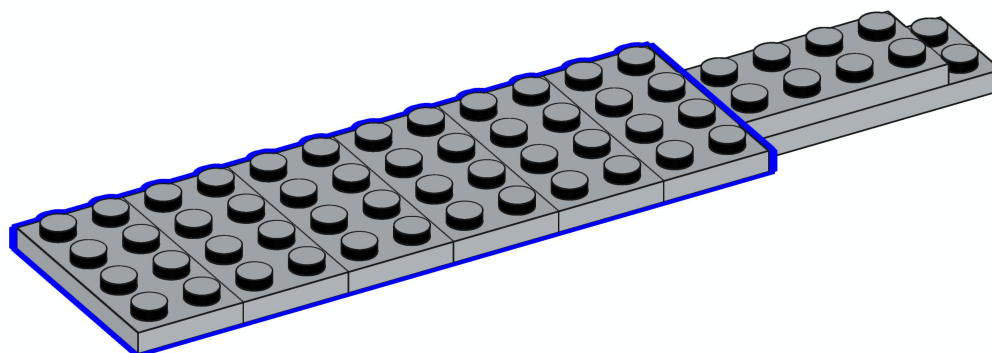

# 81



2x

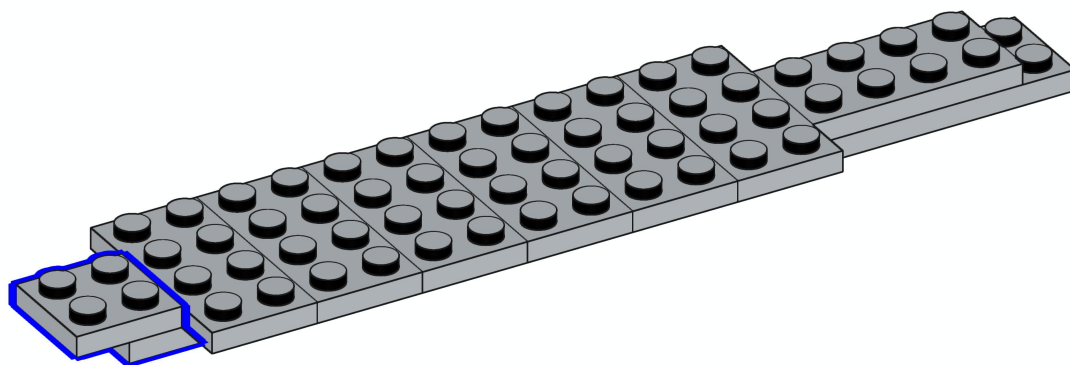

# 82

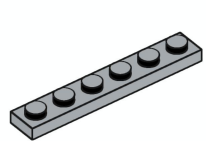

2x

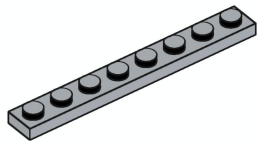

2x

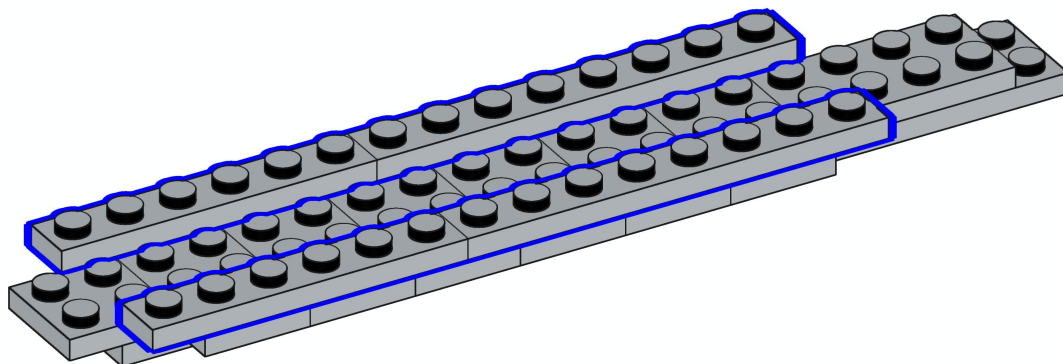

# 83



17x

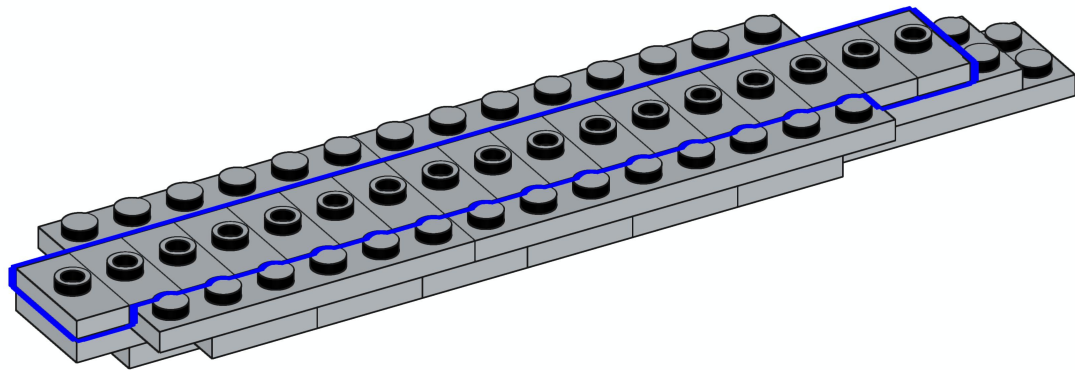

# 84

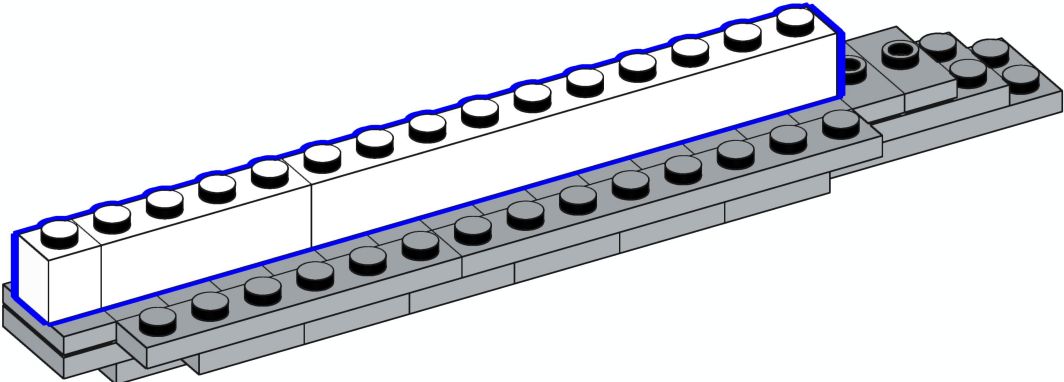
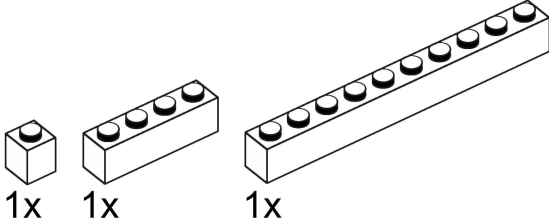

# 85

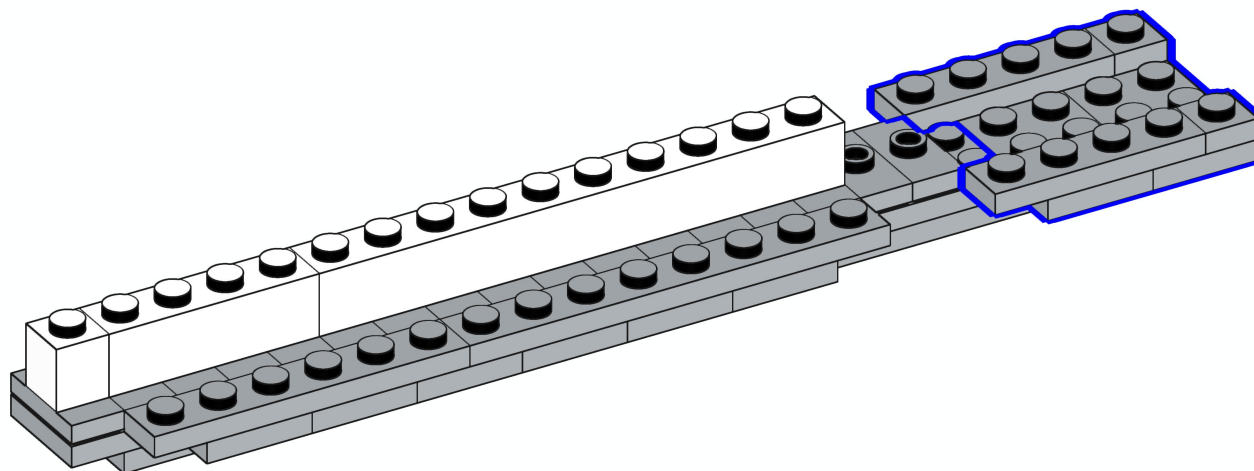
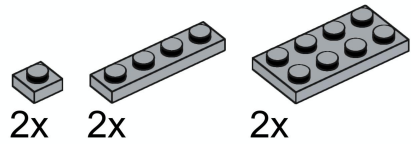



# 86



5x

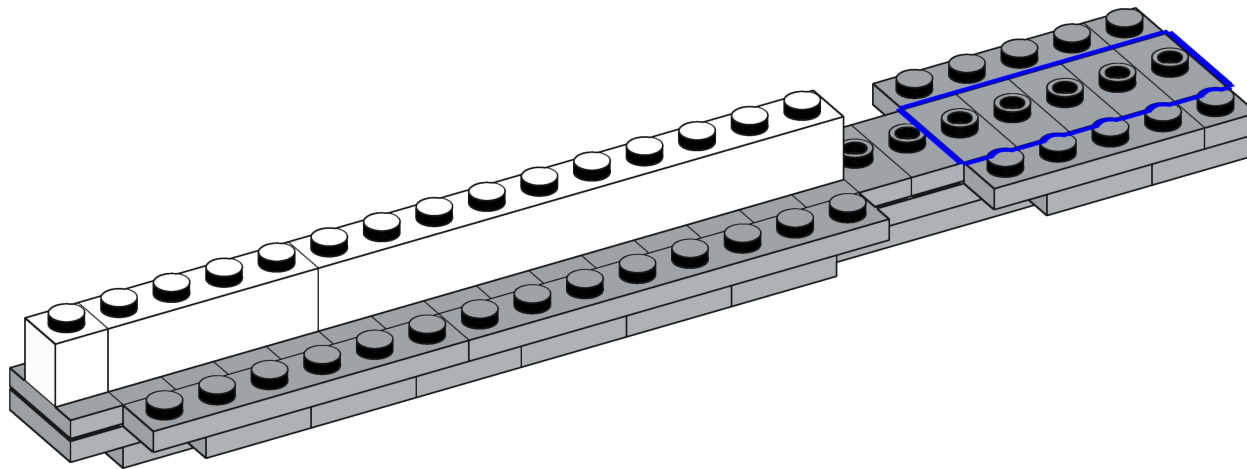

# 87

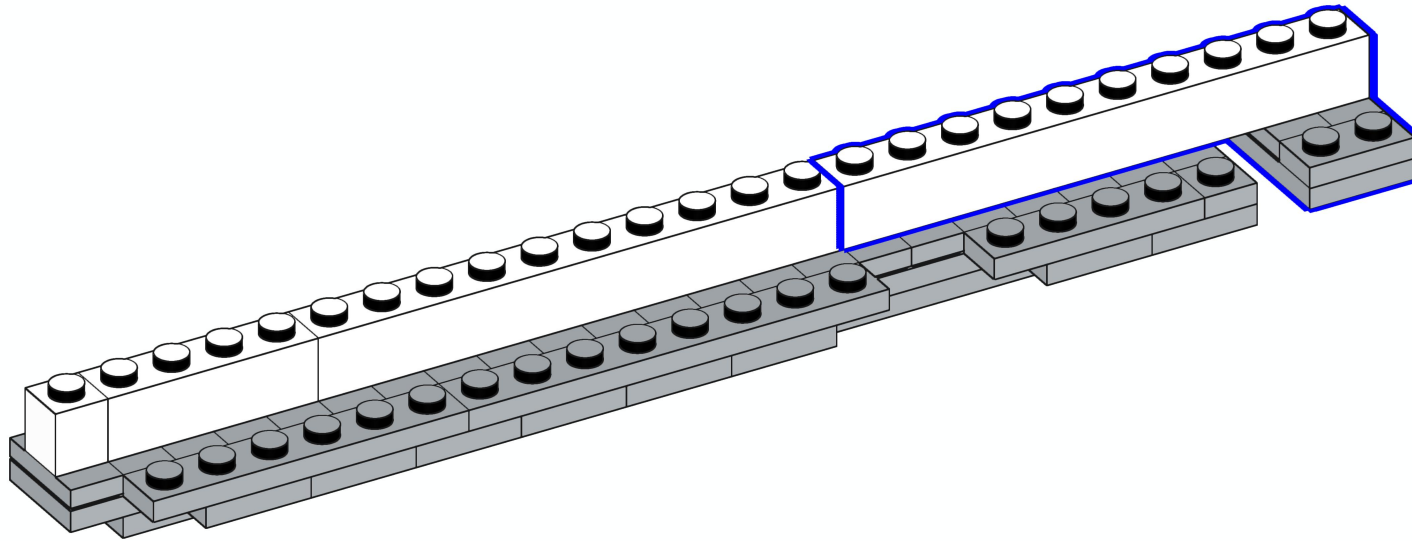
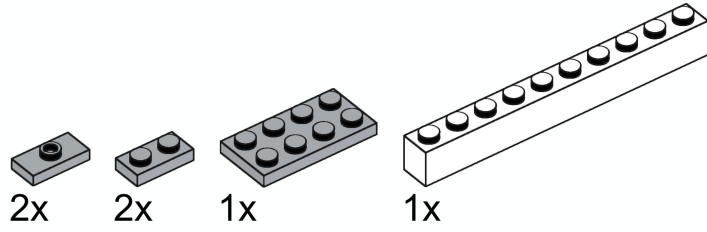

# 88

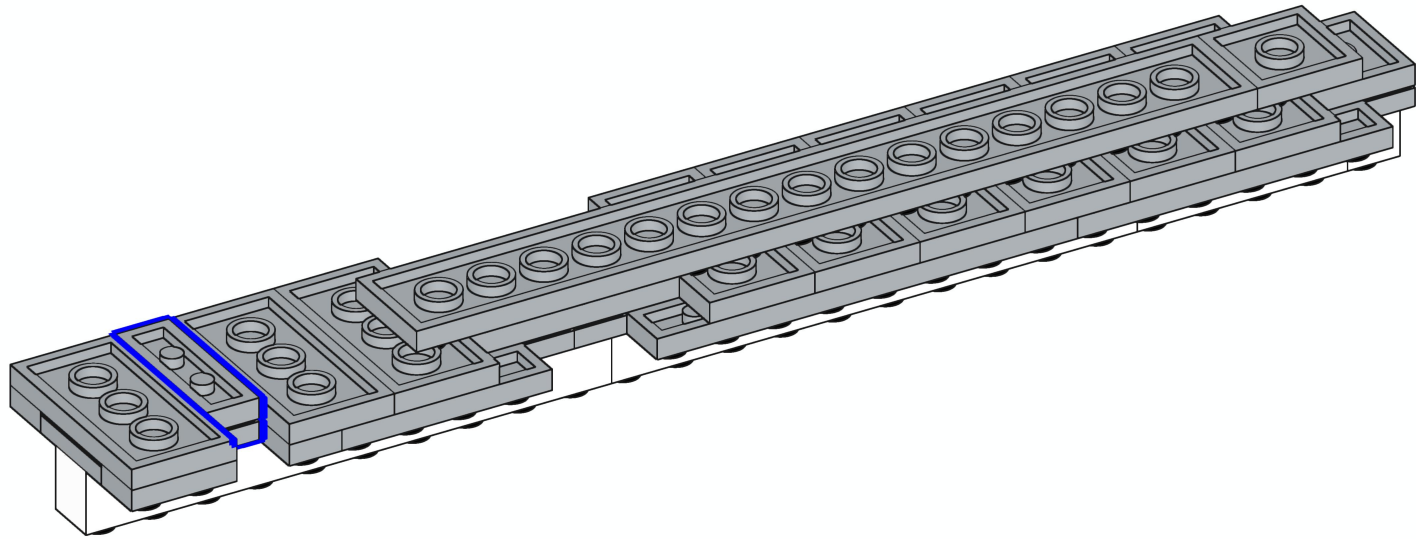
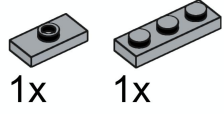

# 89



12x

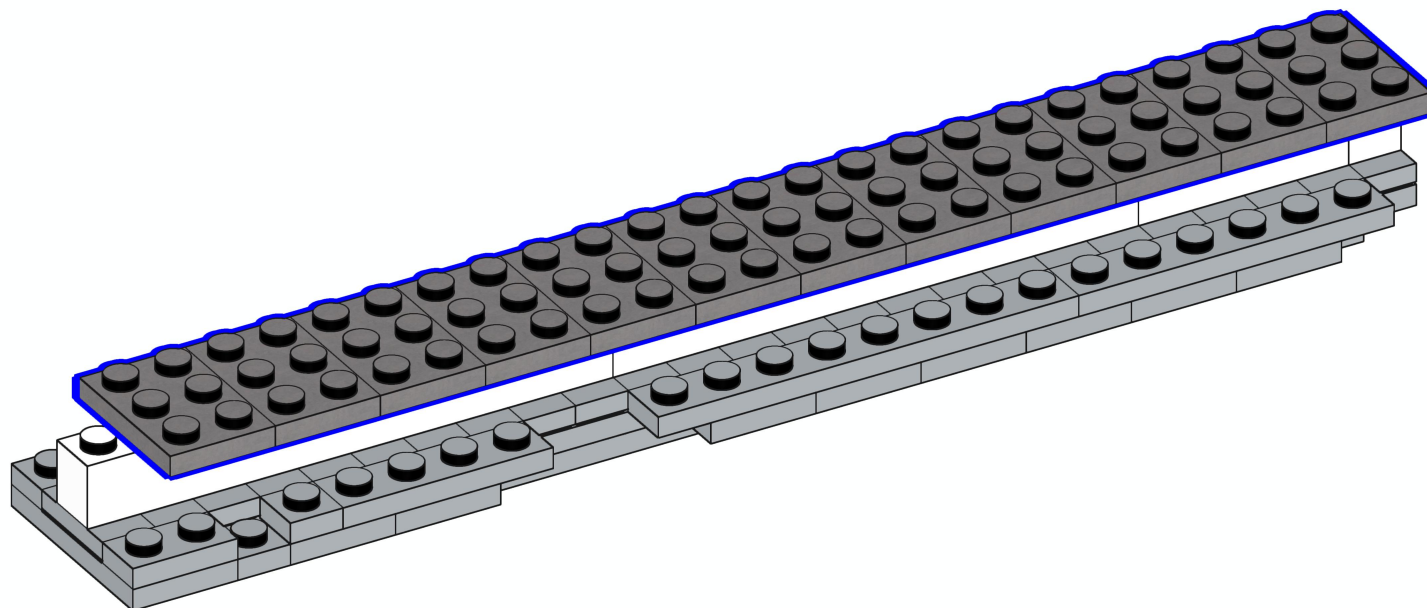

# 90

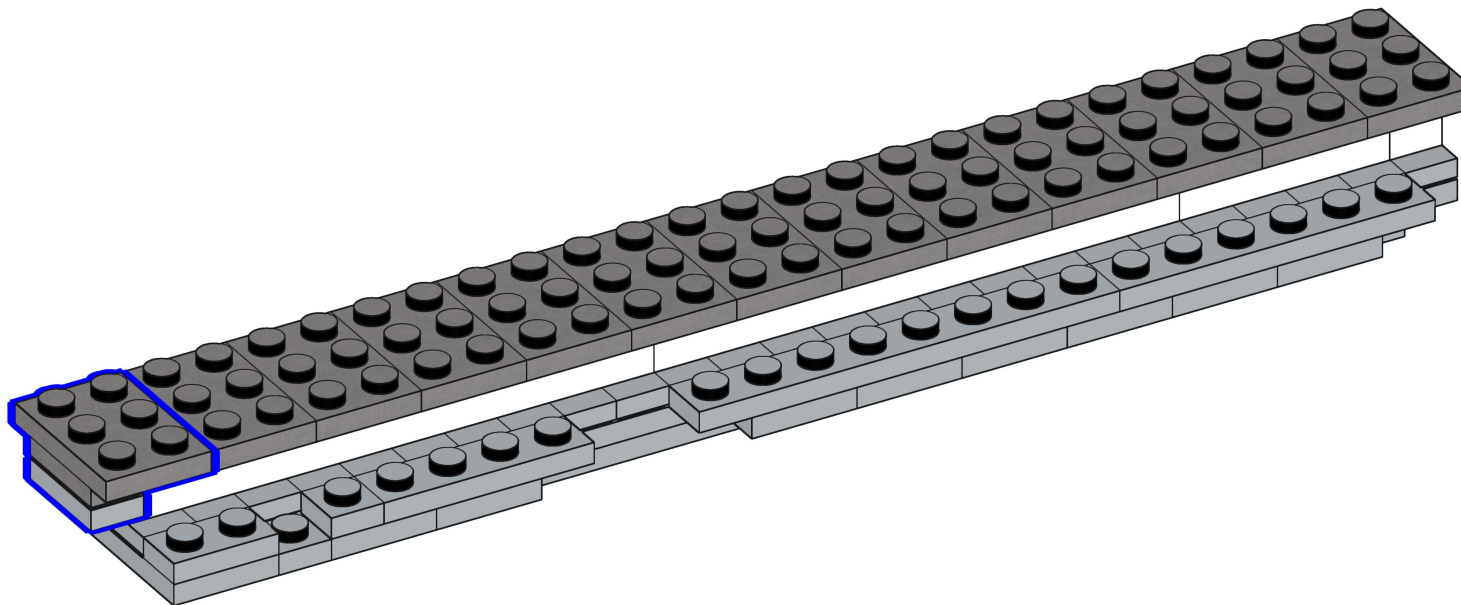
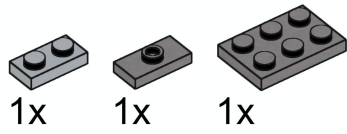

# 91



13x

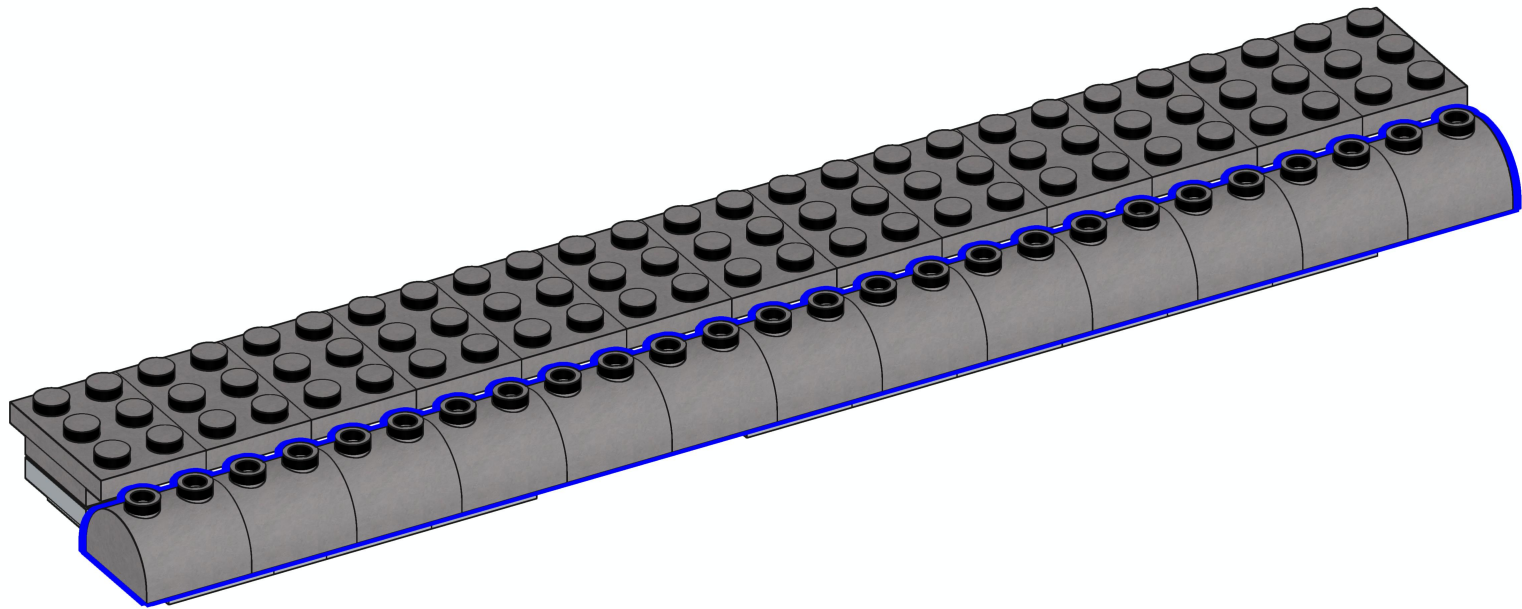

# 92



1x



1x

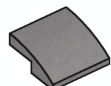

12x

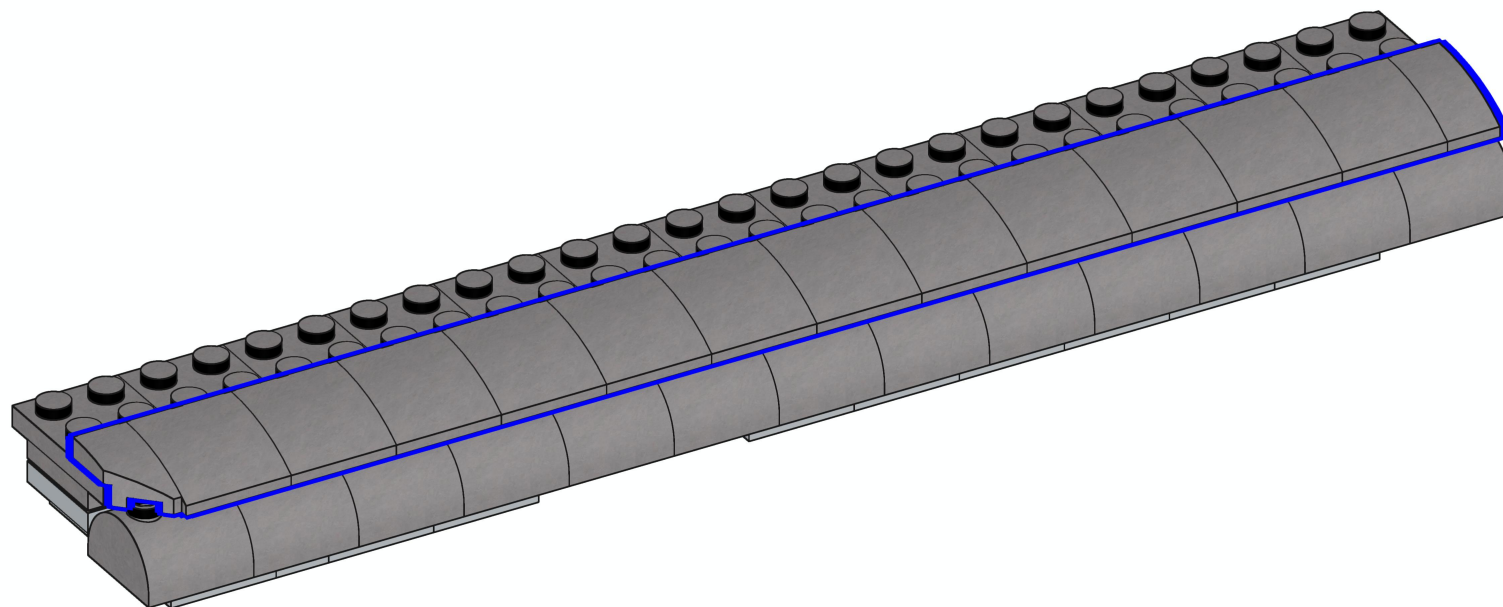



# 93



13x

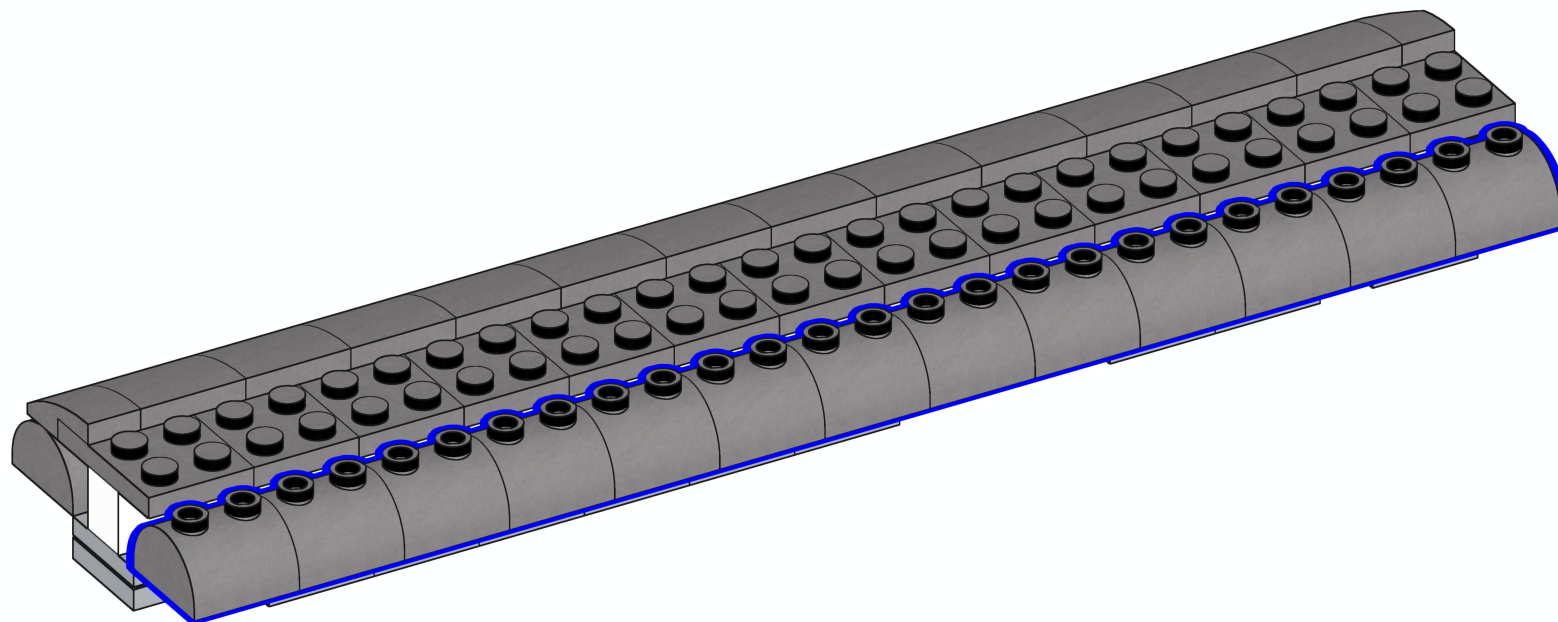

# 94

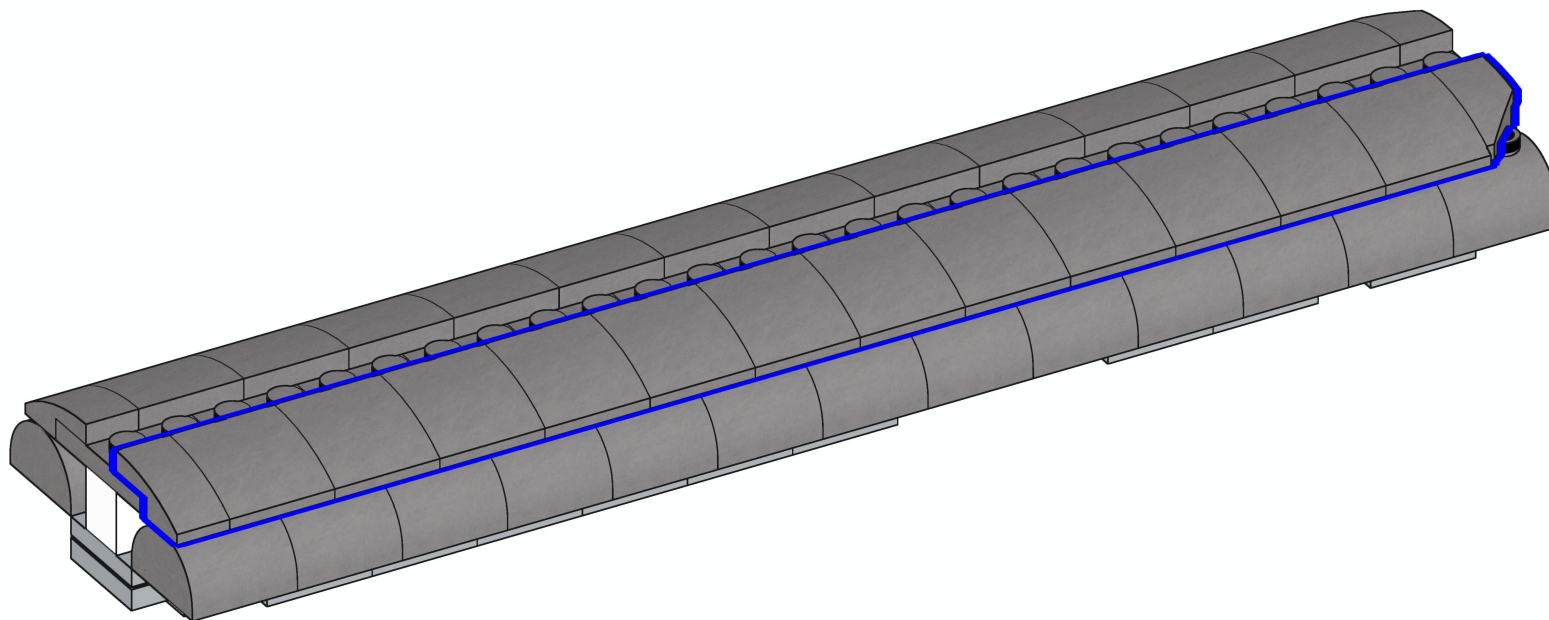
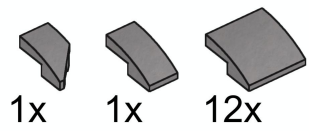

# 95



5x

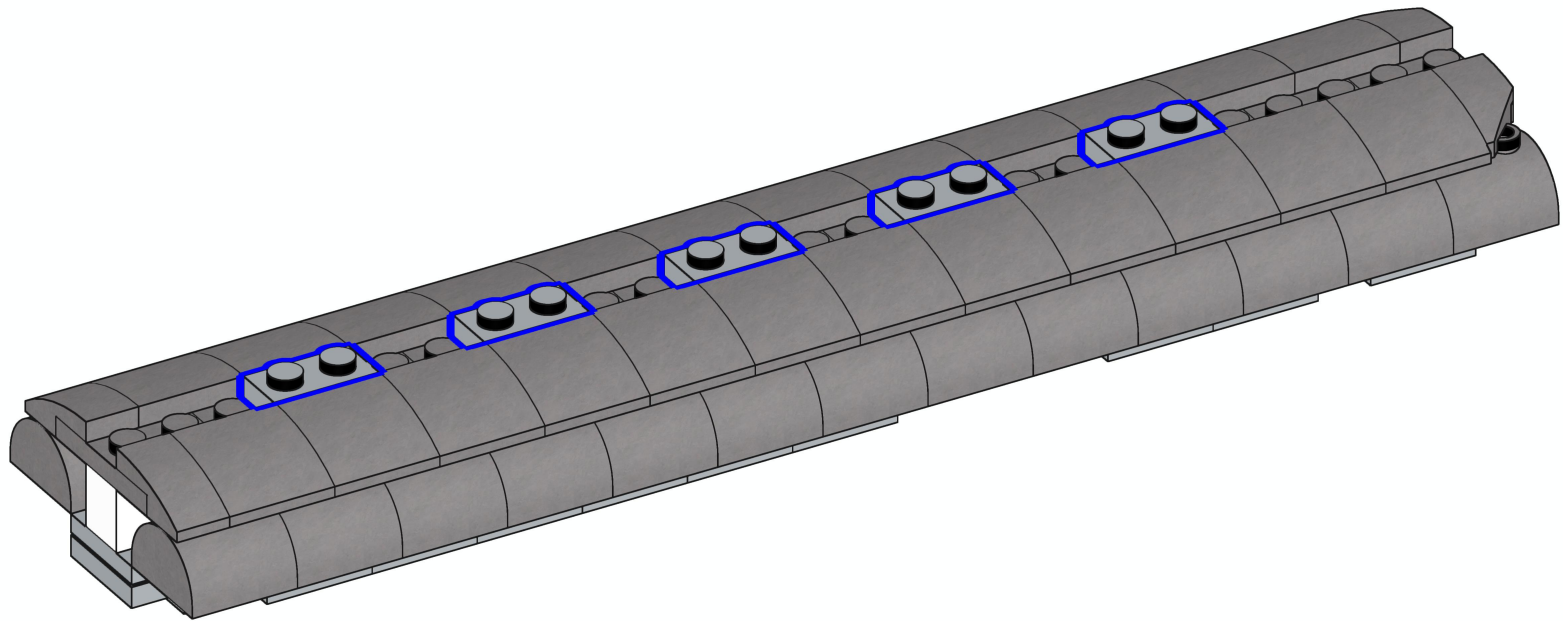

# 96

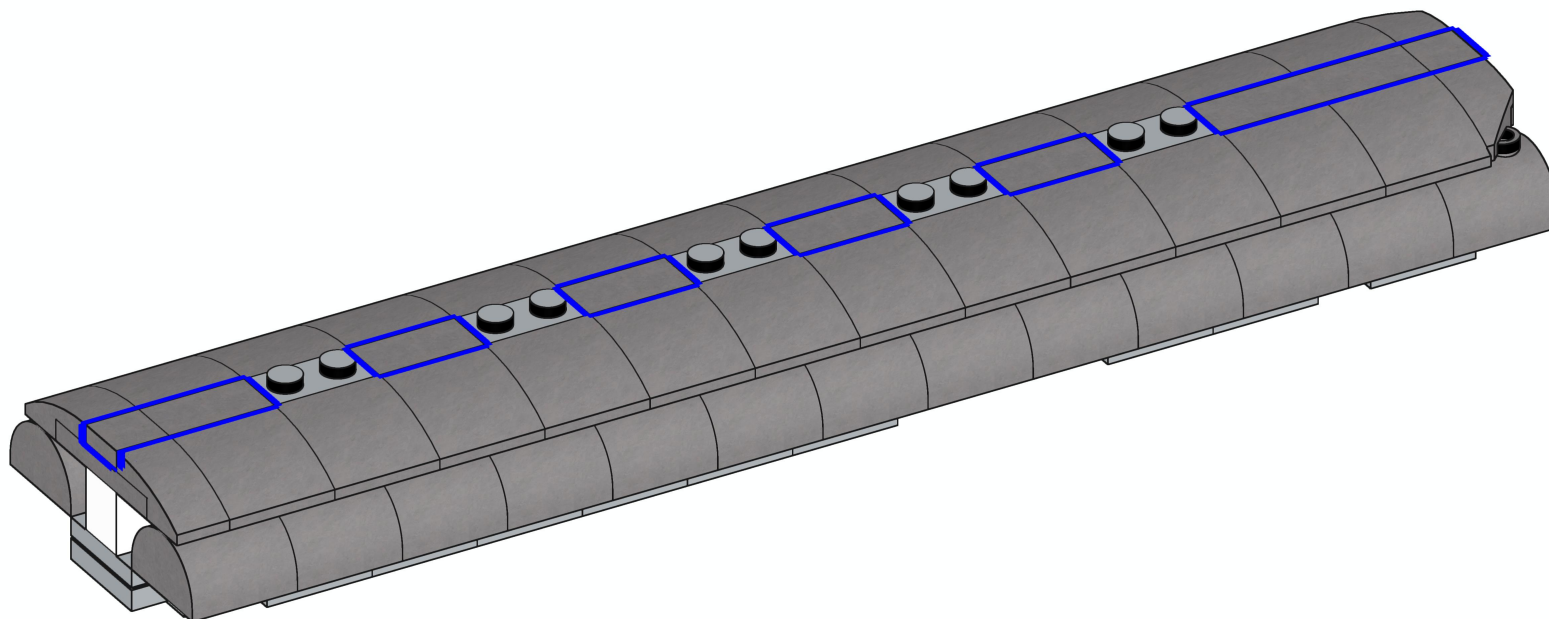
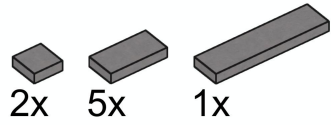

# 97



5x

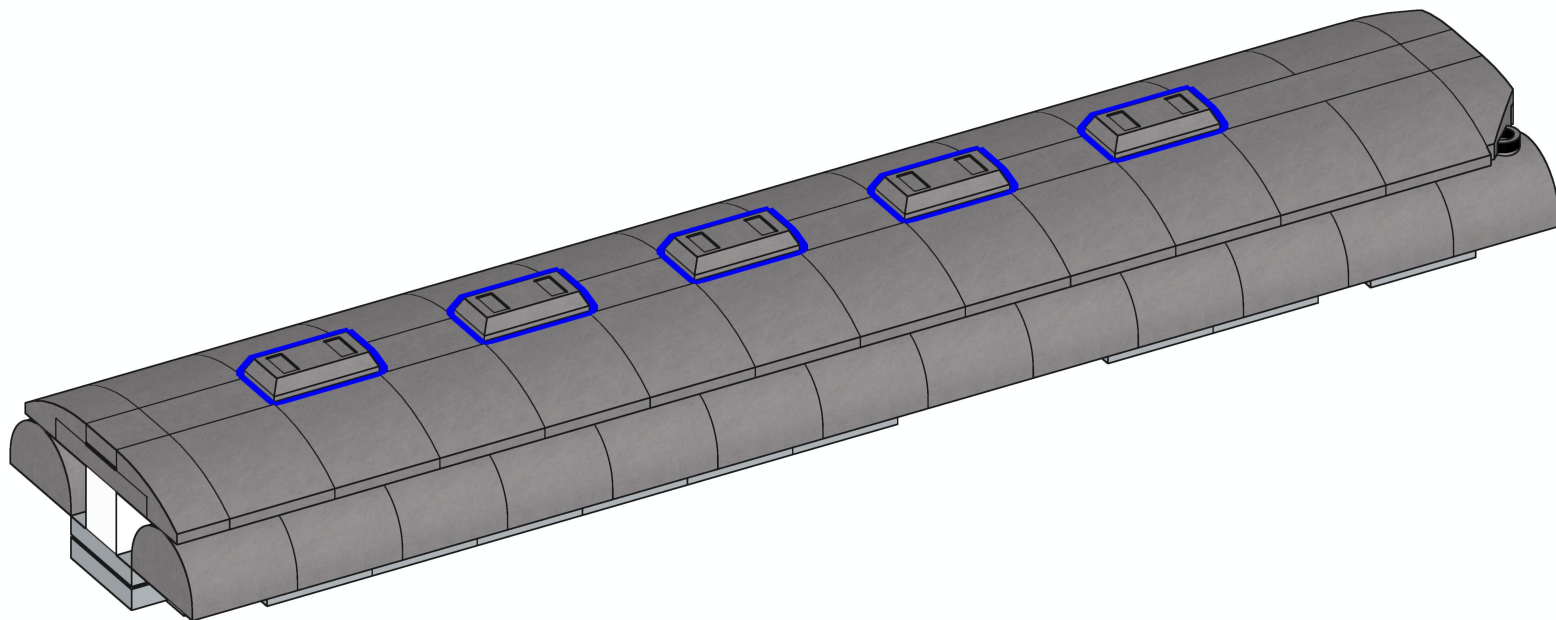

# 98

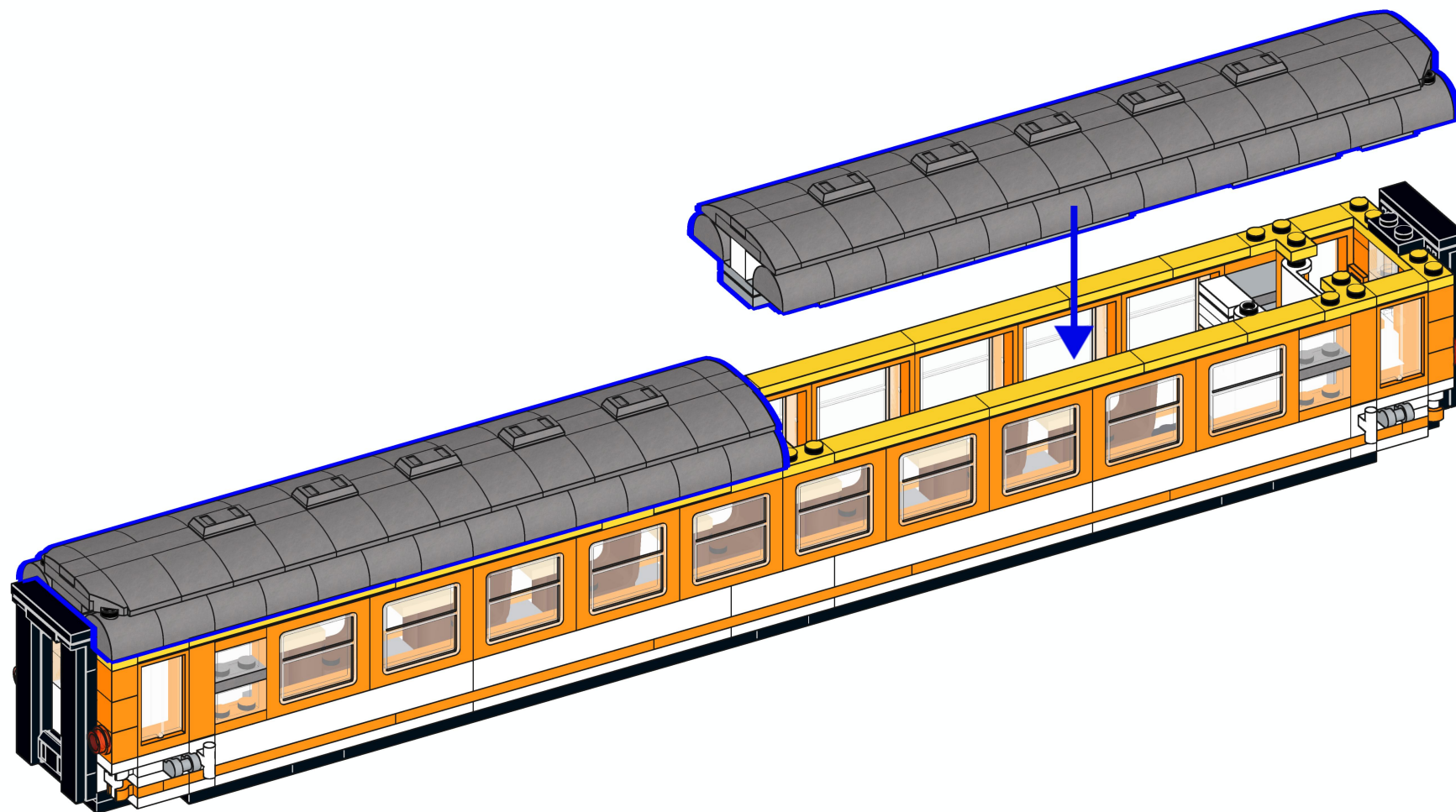



# 99



4x

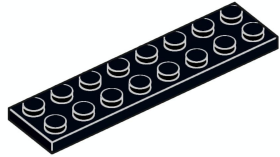

1x

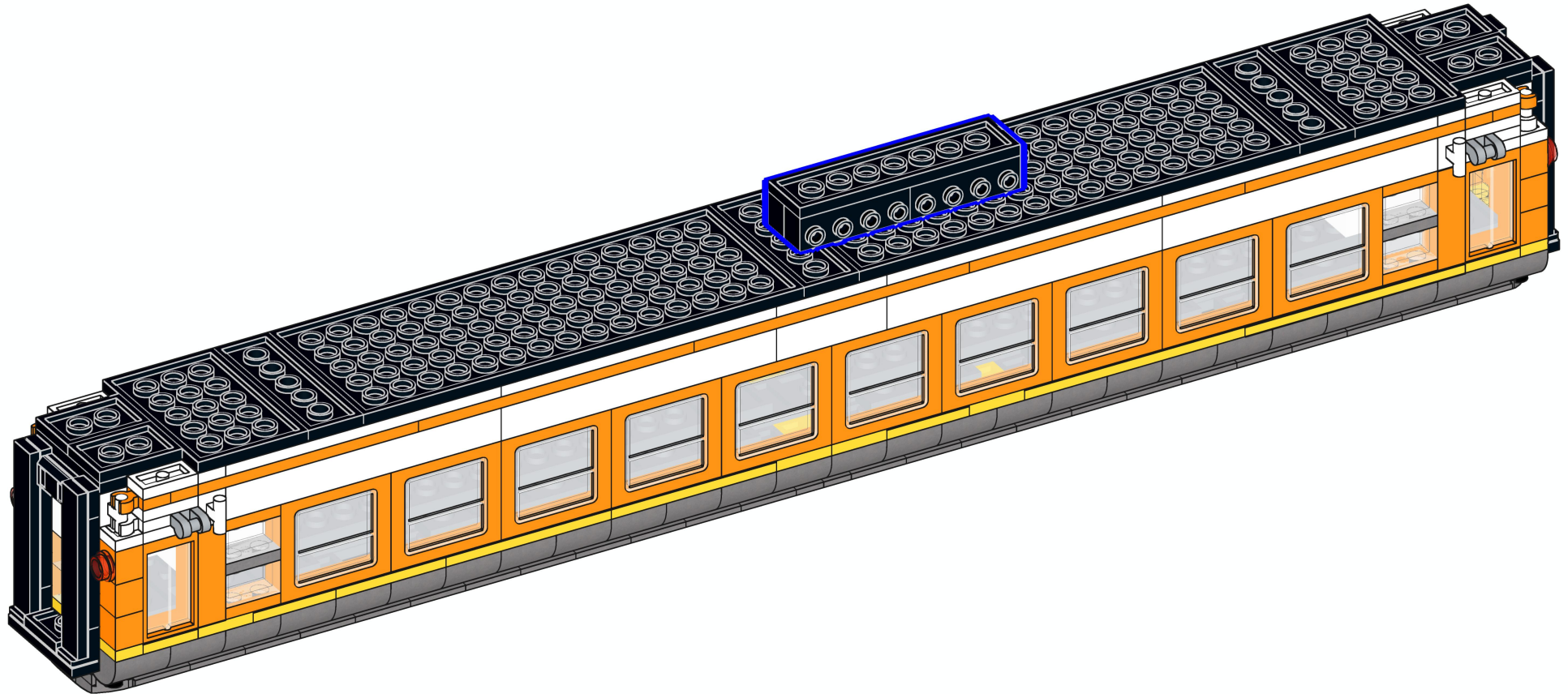

# 100

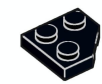

2x

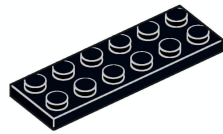

2x

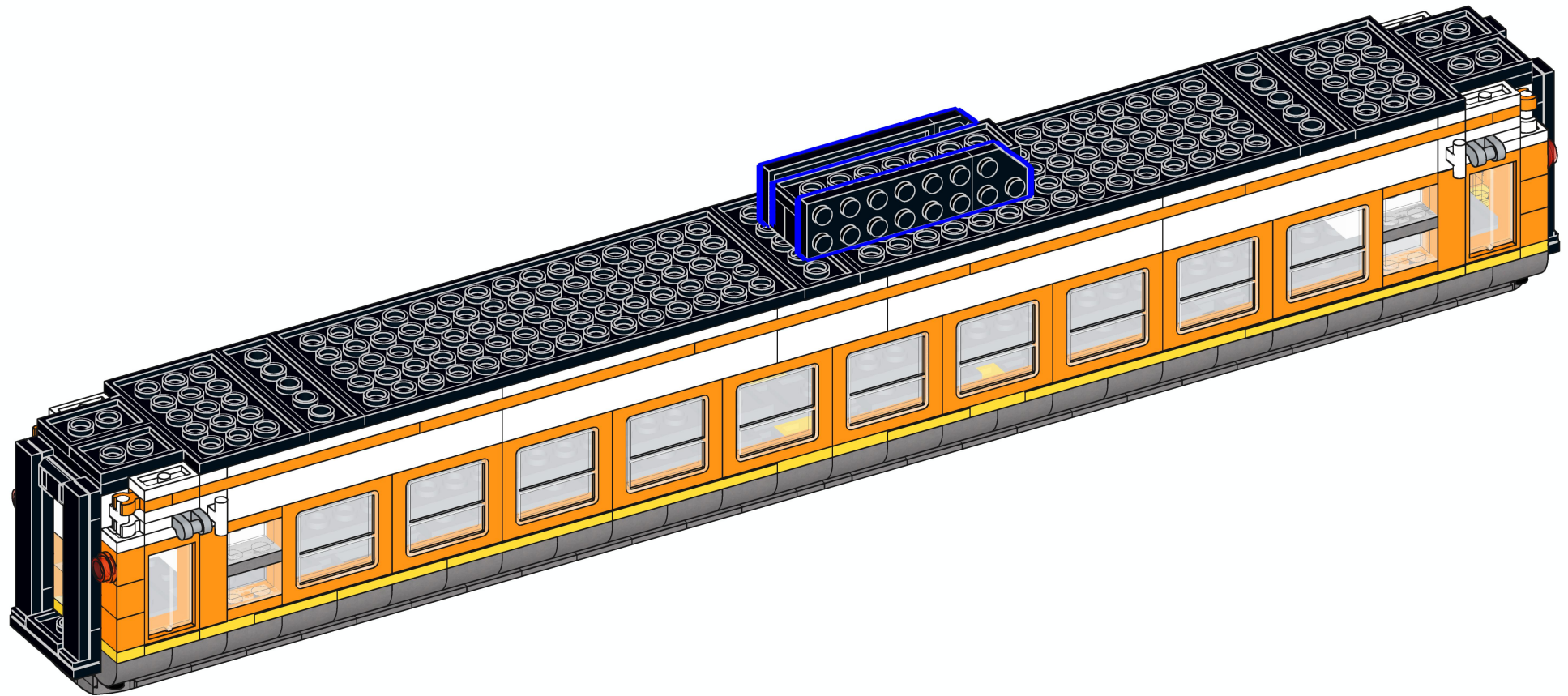



# 101

  
12x

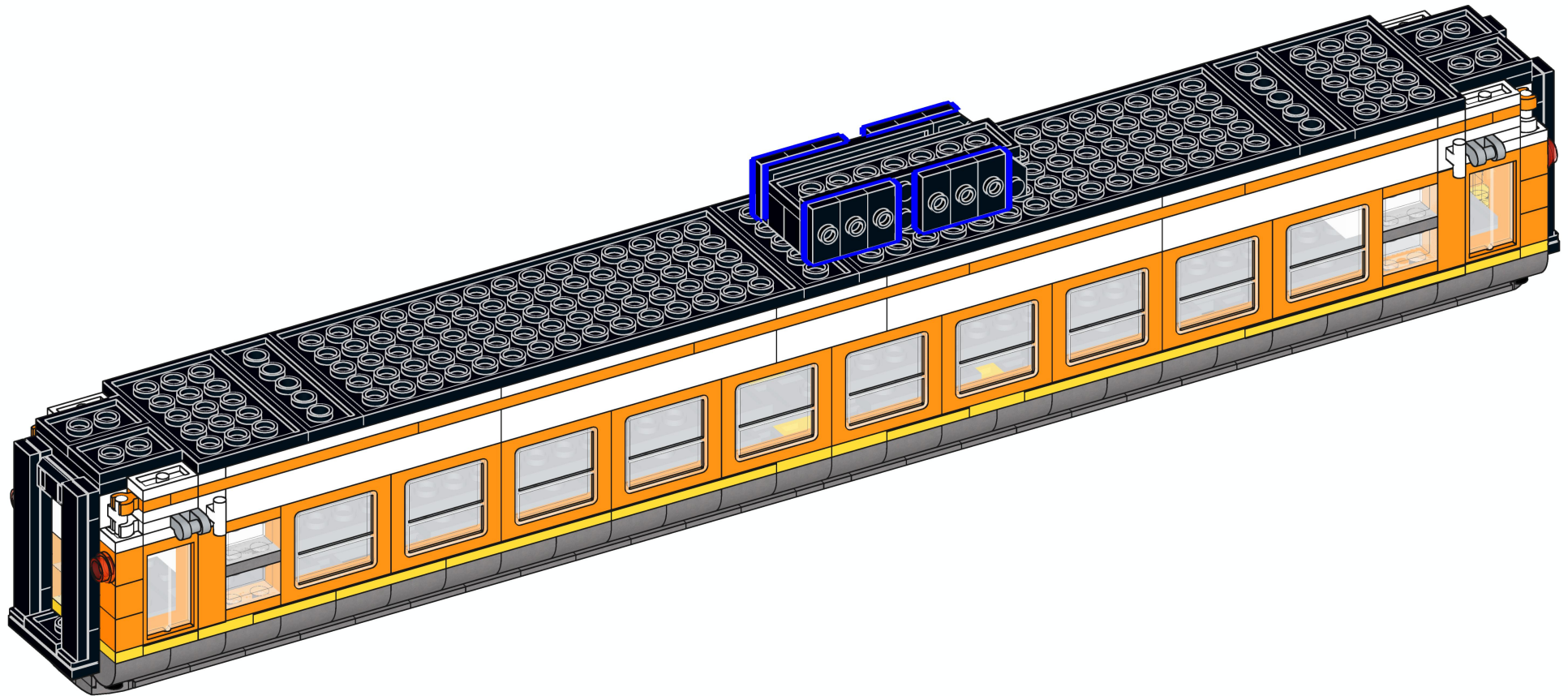

# 102

2x

4x

2x

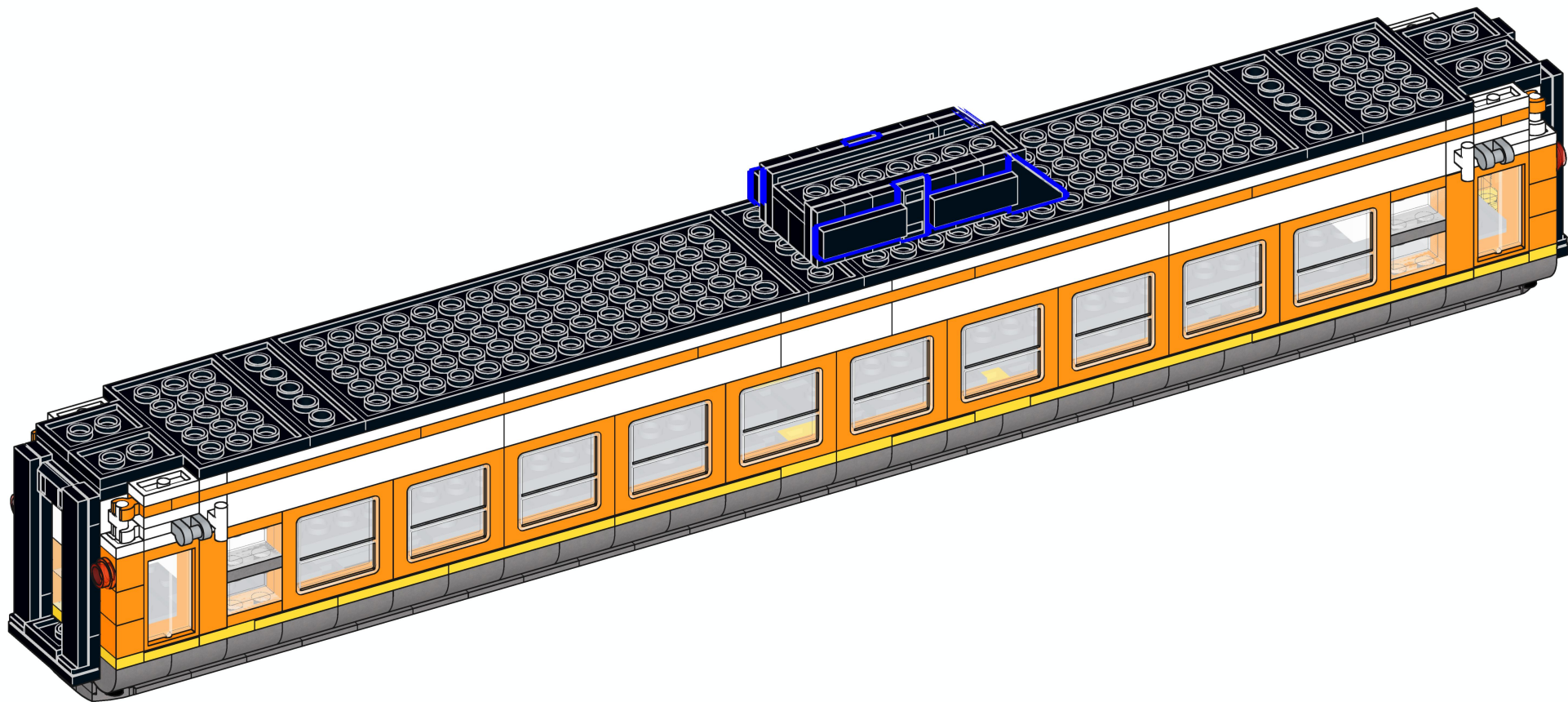

# 103



1x



2x

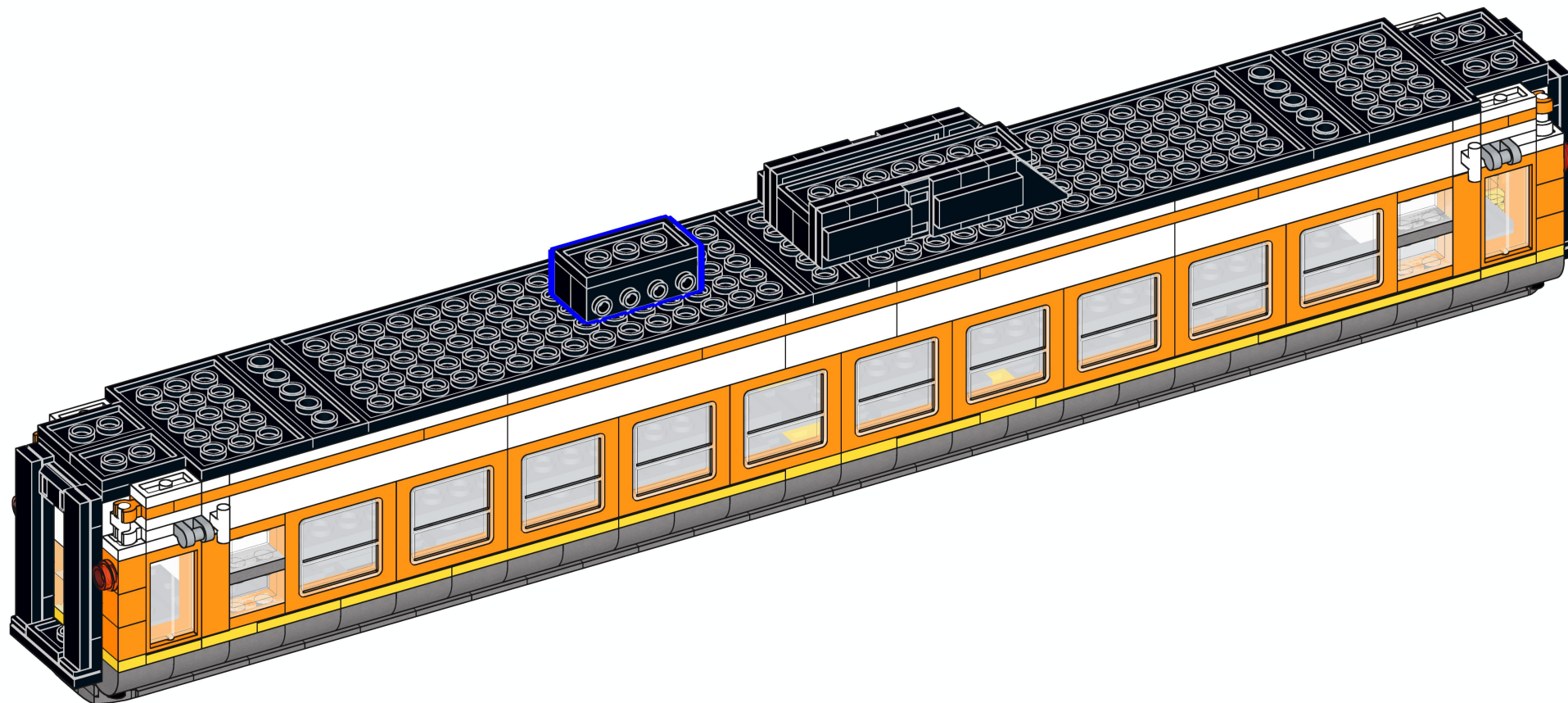



# 104

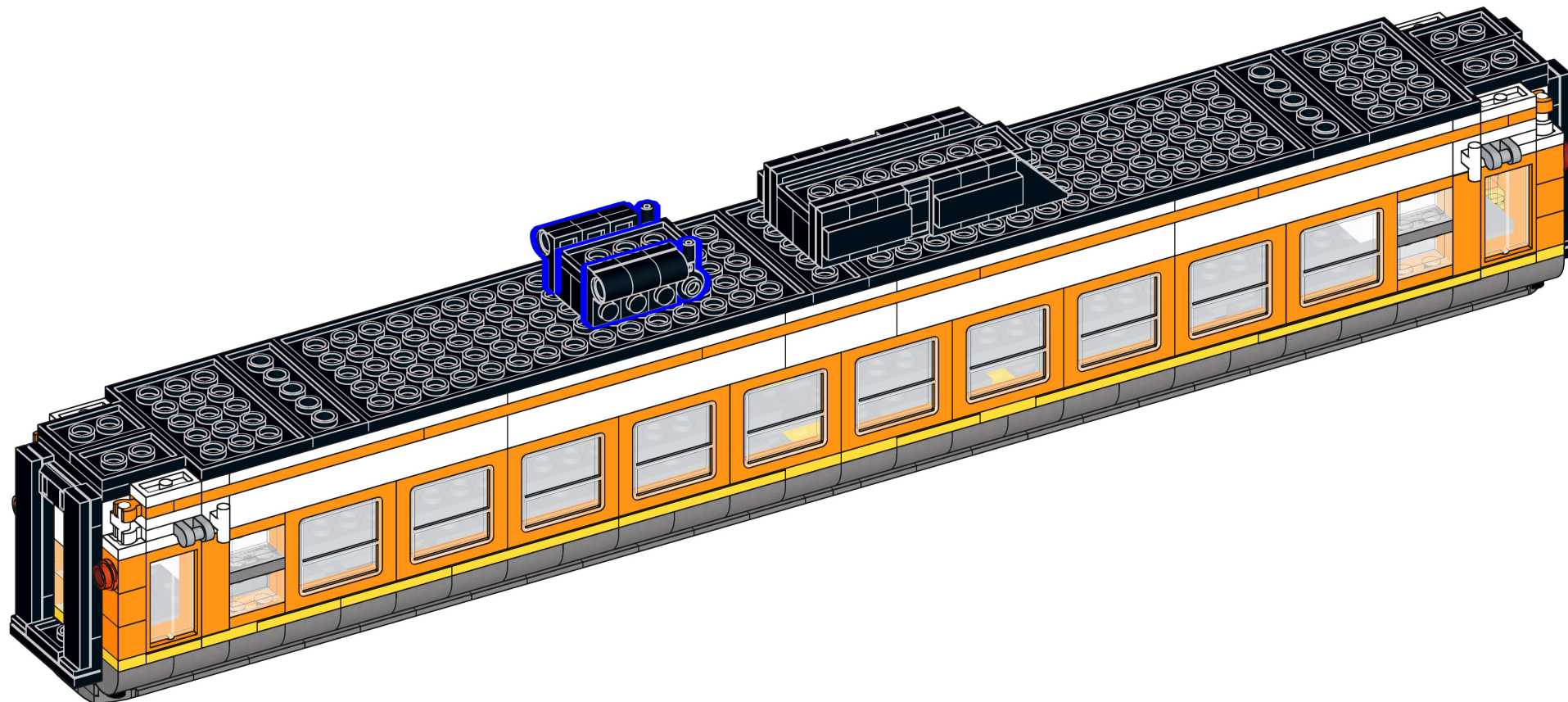

# 105



2x



2x



2x

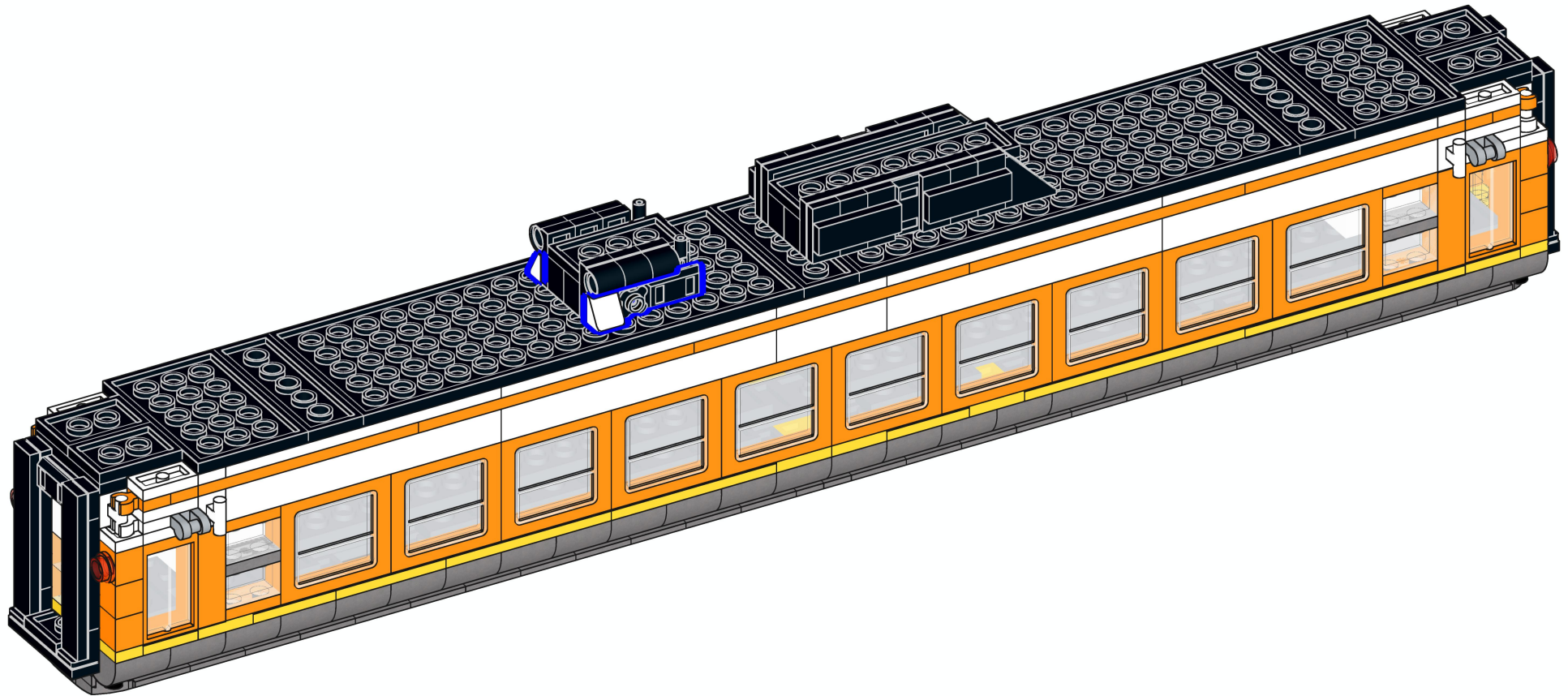

# 106



1x

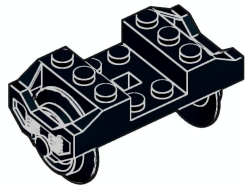

2x

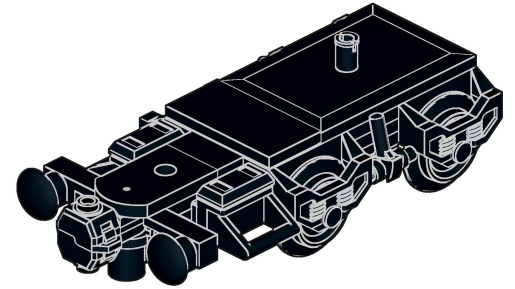

# X2

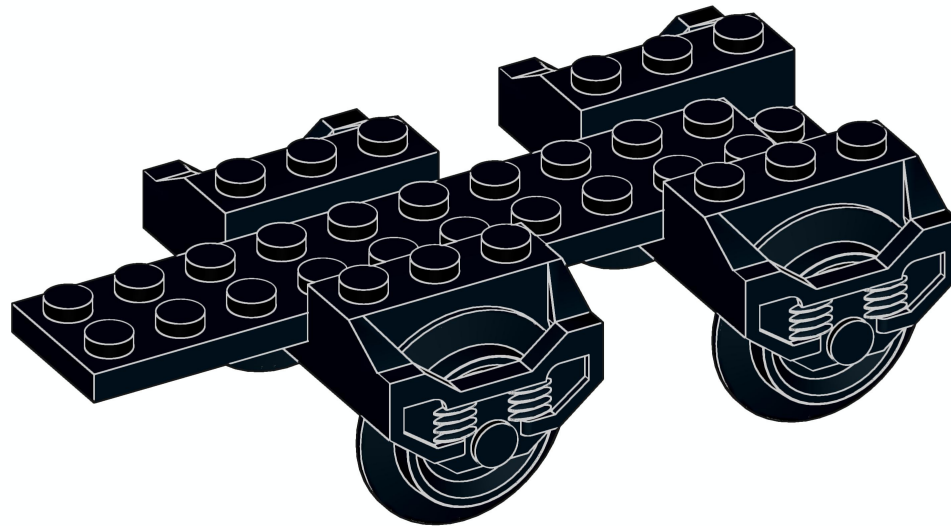

# 107

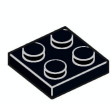

1x



1x

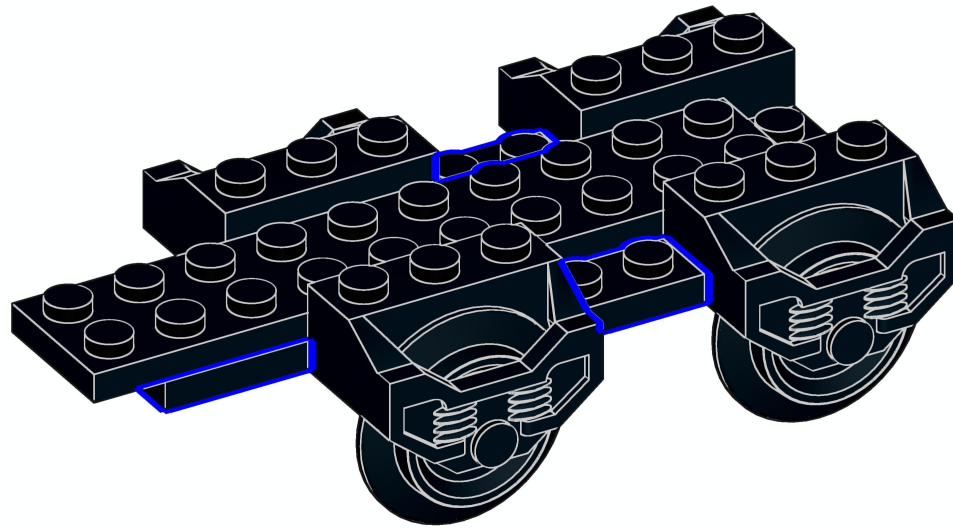

# 108

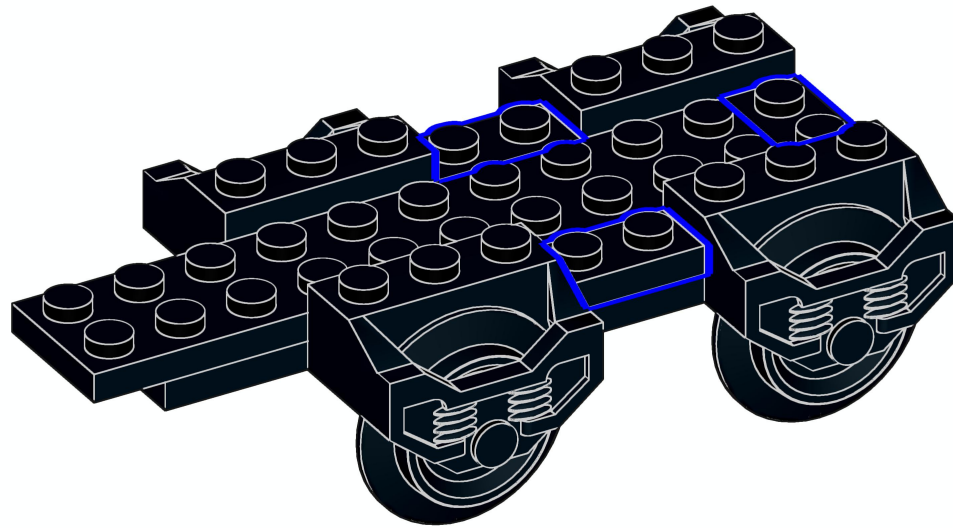
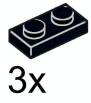



# 109



2x



1x

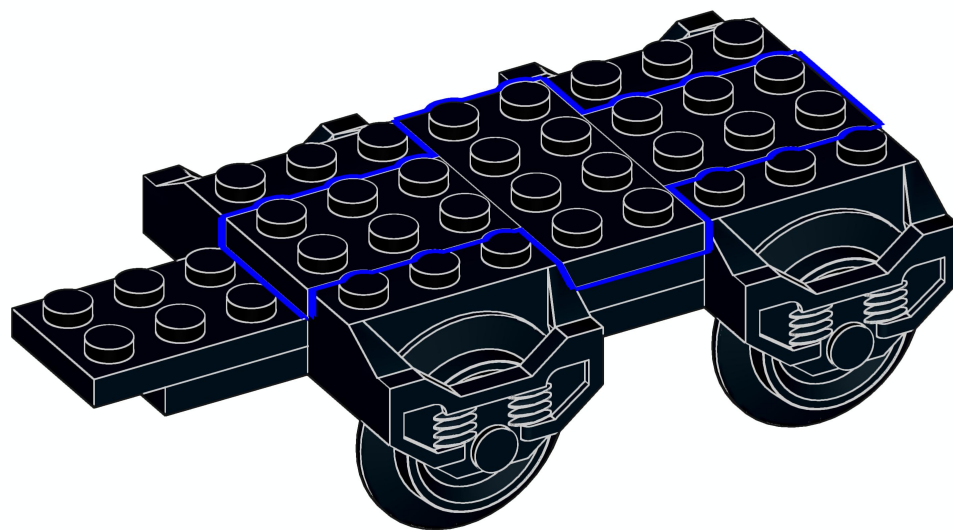

# 110

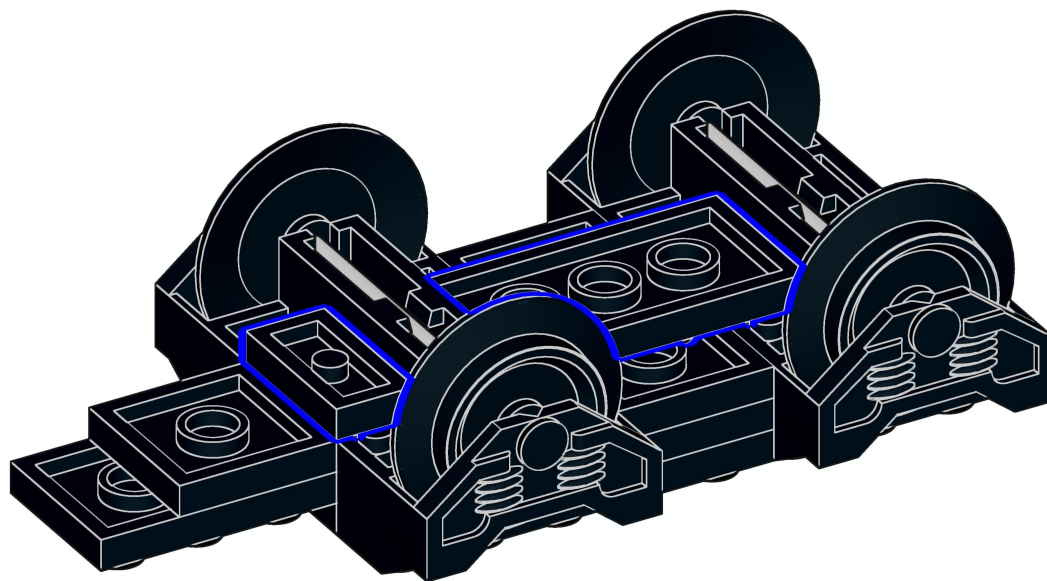
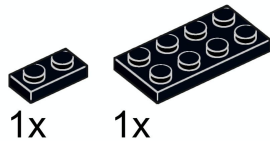

# 111

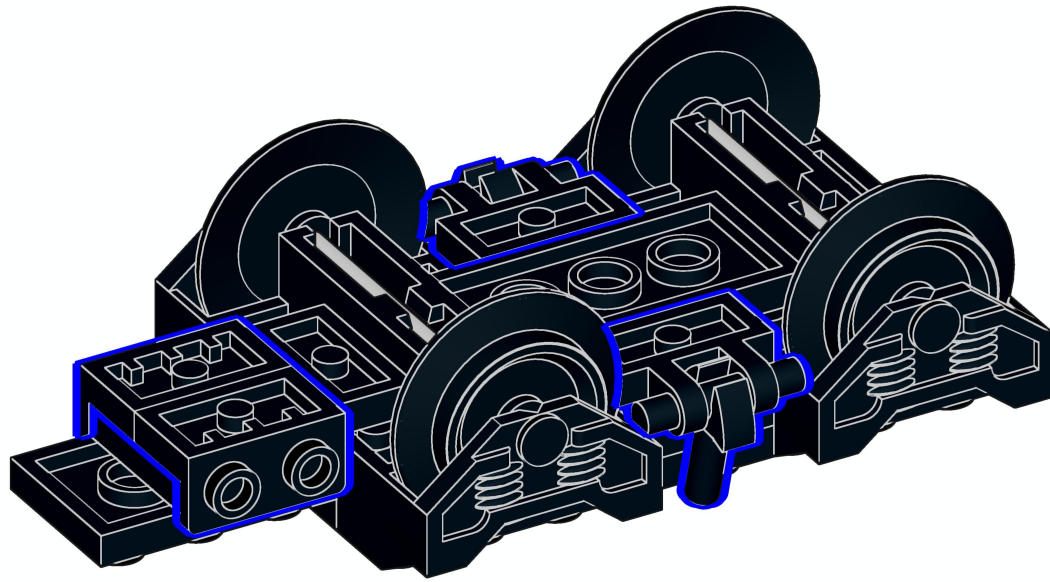

# 112

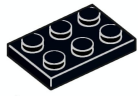

1x



1x

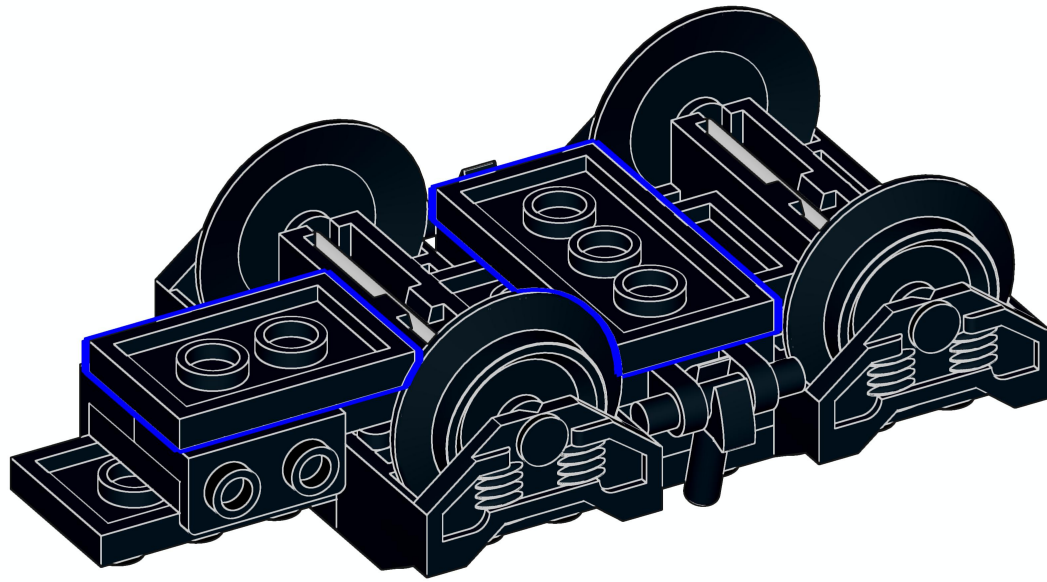

# 113

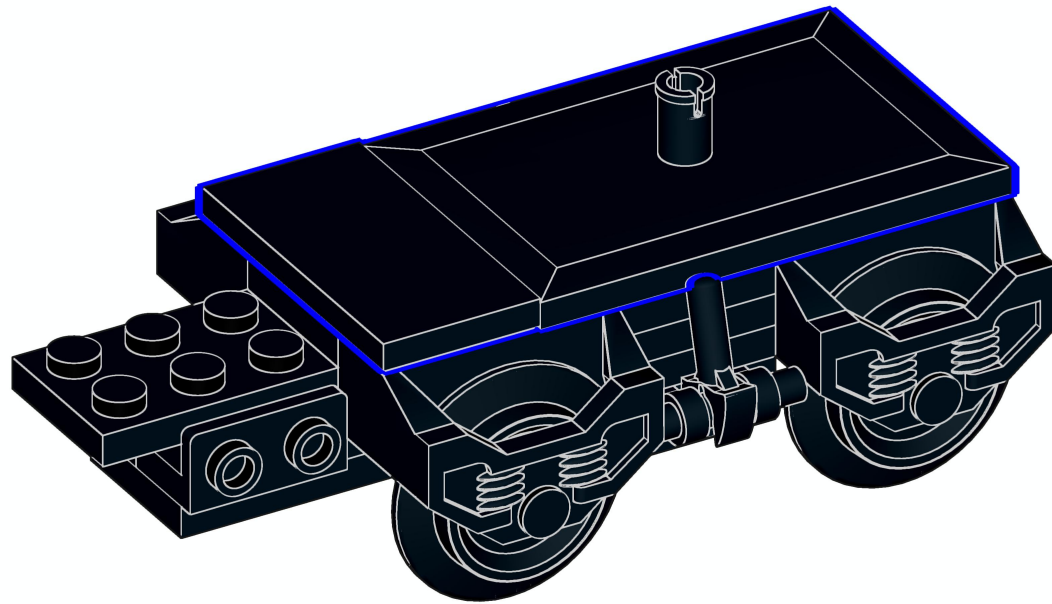
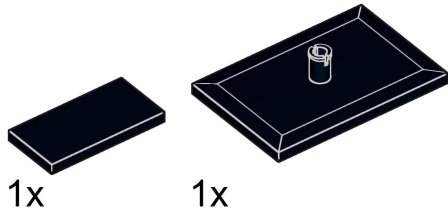

# 114



2x



2x

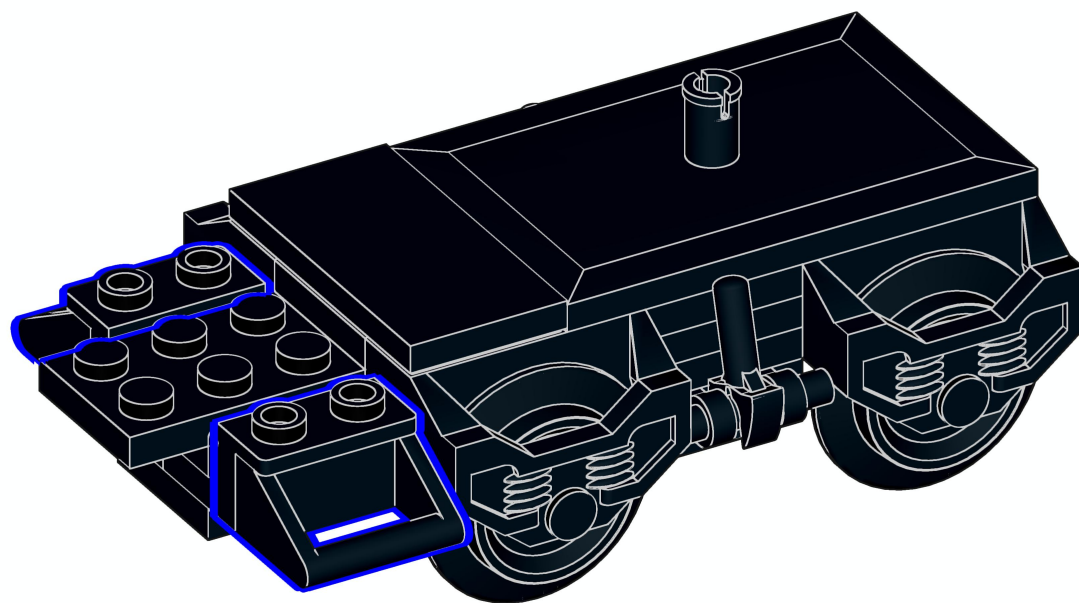

# 115

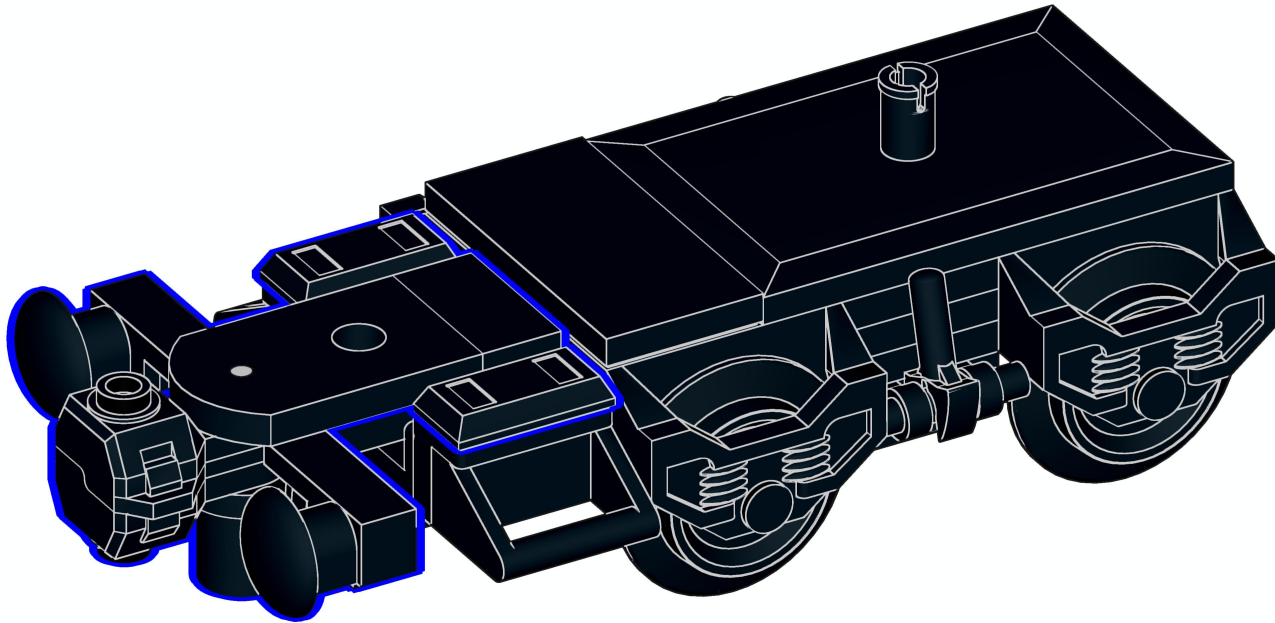
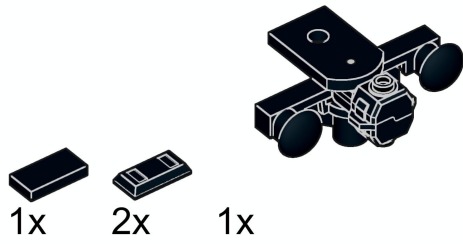



# 116

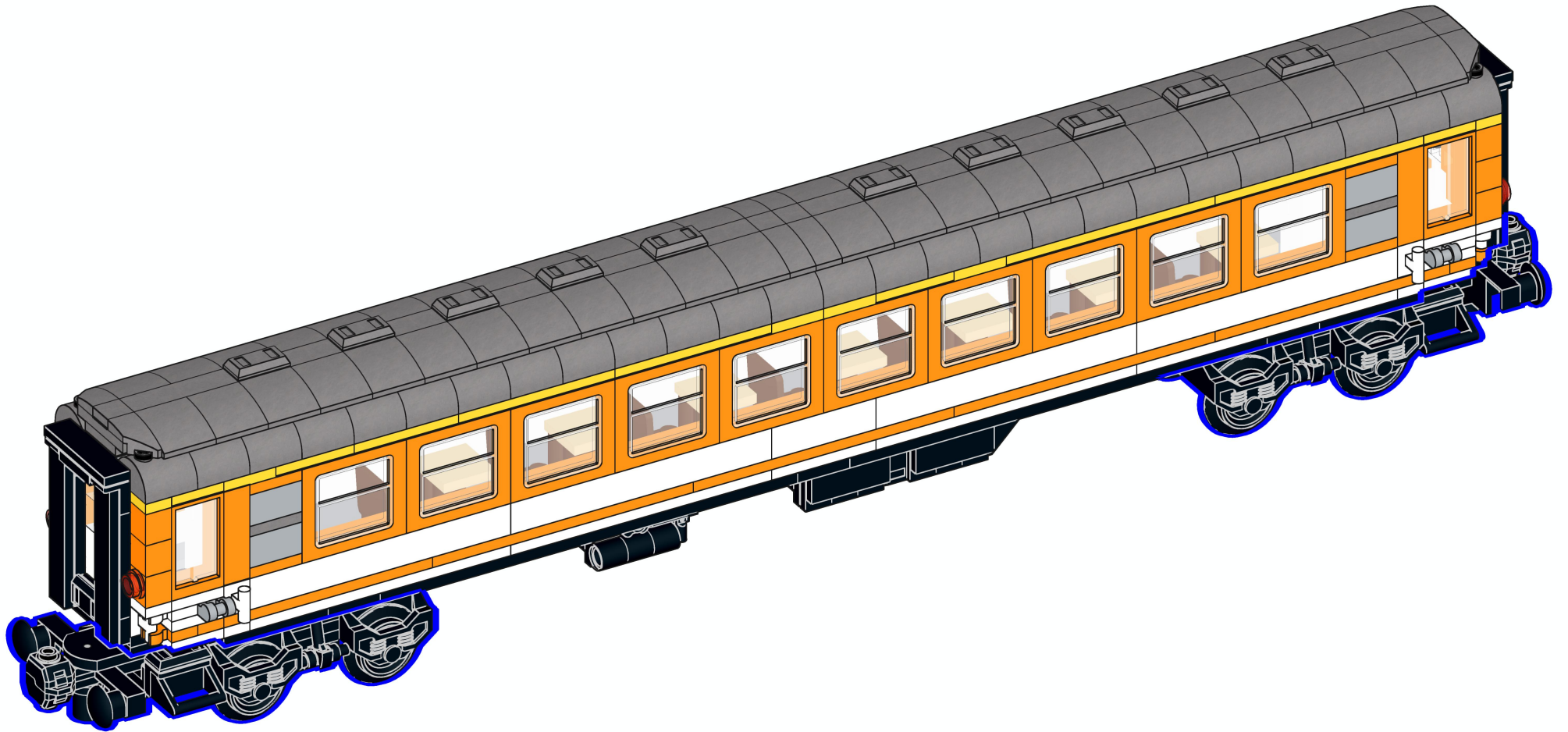





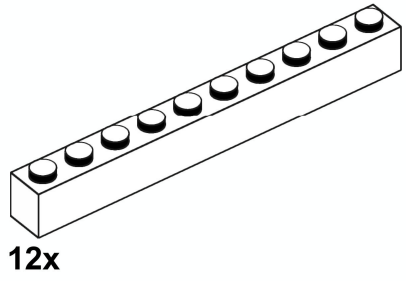

12x



4x



4x

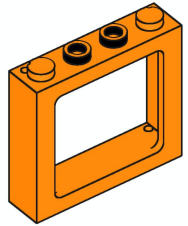

20x

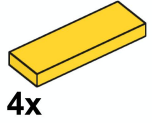

4x

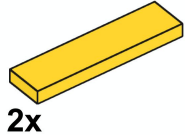

2x

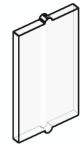

4x

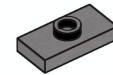

2x

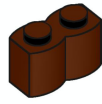

14x



4x

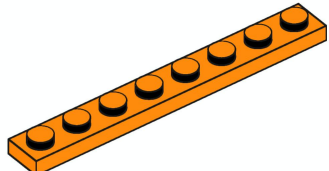

4x

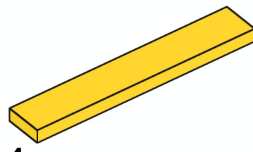

4x

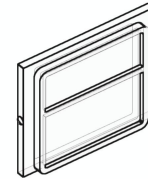

20x

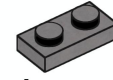

4x

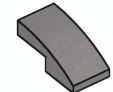

4x

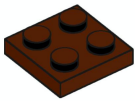

14x

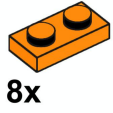

8x

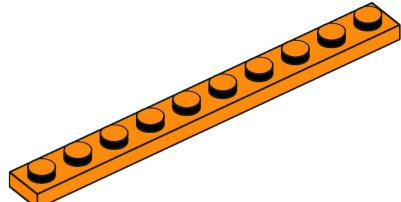

6x

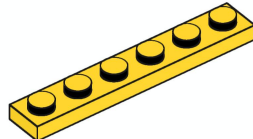

2x



4x

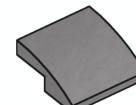

48x



7x

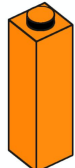

4x

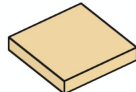

7x

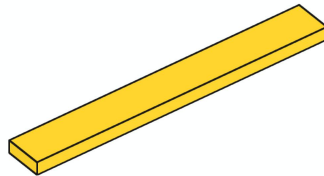

4x



4x



52x



8x



4x



4x



8x

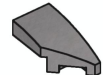

2x



26x



12x



8x



4x

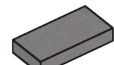

10x

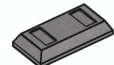

10x

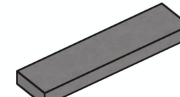

2x



4x



2x